



GEE TECH

Final Distribution

Catalogue 2021

www.se.com/uk

Life Is On

Schneider
Electric



Life Is n

SCHNEIDER ELECTRIC Leadership Position in Final Distribution

50

Experience
and attentiveness
to our customers



Leadership position
more than 1/3
market share in **Final
Distribution category**

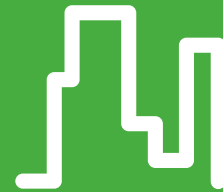

Market leading
in commercial
segment

Driving changes together through innovation

Devices evolution



Acti9, the 5th
generation of
modular systems

Distribution board evolution



Acti9 Isobar P, the
2nd generation of Isobar P
distribution boards

22

New patents

Contents

■ Introduction

Overview	Pg 3
Features and Benefits	Pg 6

■ Acti9 Isobar P distribution boards

EcoStruxure™	Pg 12
Acti9 Isobar P A type distribution boards	Pg 17
Acti9 Isobar P B type distribution boards	Pg 31

■ KQ

LoadCenter KQ overview	Pg 52
LoadCenter KQ distribution boards	Pg 54

■ Easy9 Consumer units

Easy9 overview	Pg 71
Easy9 devices	Pg 80

■ Technical section

Acti9 Isobar P technical	Pg 84
KQ Loadcenter technical	Pg 95
Easy9 technical	Pg 97

■ Dimensions and weights

Acti9 Isobar P dimensions and weights	Pg 111
KQ Loadcenter dimensions and weights	Pg 116
Easy9 dimensions and weights	Pg 121

■ Index

Index	Pg 126
-------	--------



FINAL DISTRIBUTION

Features and Benefits

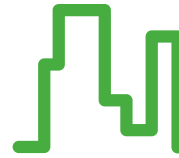

Commercial



Residential

Features and Benefits	Isobar P	KQ	Easy 9
Switchable Neutral	✓		
Plug on Neutral RCBO (PoN)	✓		
Isolation of outgoing ways (Isobar interlock)	✓		
5 Year distribution board warranty registration	✓		
IP2X internal protection	✓		
Visi - trip window on outgoing devices (Fault indication window)	✓	✓	
Power Tag wireless energy sensor for all going devices	✓		
Outgoing 4 pole device	✓		
250amp rated busbar	✓	✓	
BS/EN 60947-2 (Icu 15kA)	✓		
BS/EN 60898-1 (Icn 10000A)	✓	✓	
Encapsulated bus bar – pan assembly	✓	✓	
Secure finger safe pan assembly	✓	✓	
Guaranteed plug on connections - quick plug on devices	✓	✓	
One less terminal to torque test		✓	
Plug in devices		✓	
Clip in busbar cover, requires tool for removal	✓	✓	✓
Finger proof touch terminals on outgoing devices	✓	✓	✓
Class II front face devices	✓	✓	✓
Increased cabling space	✓	✓	✓
Reversible door orientation			✓
Semi flush mounting frame			✓
Re-positionable signature strip			✓
BS7671 Enclosure			✓

* PoN - Plug on Neutral RCBO

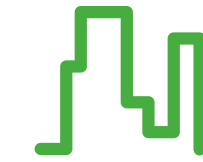

Commercial



Residential

Features and Benefits	Isobar P	KQ	Easy 9
Pictogram circuit way labels			☑
Larger foot print - reduce remedial decorating costs			☑
Incoming cable clamp option			☑
Magnetic cover closure			☑
Clear visible terminal numbering			☑
Lockable on site for second fit safety - a board designed for construction in mind.			☑
Clear pictogram installer guide			☑
Multiple entry points to accommodate varying installations			☑
Full metal enclosure, no compromise on safety.			☑
Rounded corners reducing impact injuries			☑
Visi trip RCCB			
Circa 30% increased in cabling space			
Insulated pull up shuttered device terminals			
Circa 40% increased in cabling space			☑
Access behind the din rail for incoming cables that enter on the opposite side			☑
Side mounted neutral bars to alleviate excessive cabling at the top of the board			☑
Shuttered device terminals			☑
Secure DIN rail			☑
Rigid metal busbar			☑
Raised busbar for cabling clearance			☑
Cabling ways under book ends			☑
Conventional busbar system			☑



Acti9 Isobar P

Contents

■ Introduction

Acti9 Isobar P overview	Pg 11
EcoStruxure™	Pg 12
What's new with Acti9 Isobar P?	Pg 14

■ Acti9 Isobar P A type distribution boards

Single Phase Distribution overview	Pg 17
Acti9 Isobar P single phase A type distribution boards	Pg 18
Acti9 Isobar P A type incoming devices	Pg 19
Acti9 iC60H circuit breakers	Pg 20
Acti9 iC60H PoN RCBO 10,30 and 100mA PoN	Pg 21
Acti9 iC60H RCBO 10, 30, 100mA	Pg 22
Accessories	Pg 27

■ Acti9 Isobar P B type distribution boards

Three Phase Distribution overview	Pg 31
Acti9 Isobar P single phase B type distribution boards	Pg 32
Acti9 Incoming devices for B Type distribution boards	Pg 34
Acti9 iC60H circuit breakers	Pg 37
Acti9 iC60H PoN RCBO 10,30 and 100mA PoN	Pg 39
Acti9 iC60H RCBO 110V (Ph/N) 30mA	Pg 41
Complimentary Devices	Pg 43
Accessories	Pg 44
Connectivity	Pg 48



Acti9 Isobar P distribution boards



The evolution of low voltage electrical distribution continues with the demands for reliability, enhanced safety, cost reduction and connectivity ever increasing.

Through market leading innovations for over a quarter of a century, Isobar P distribution boards have enabled this evolution and offered new levels of performance.

- 1st outgoing way disconnect feature
- 1st integrated neutral switching function
- 1st integrated incoming metering functions
- Enhanced safety with the introduction of Acti9 devices and functionality



PoN Plug on Neutral

Acti9 Isobar P distribution boards now offer new unparalleled reliability, safety and simplified installation whilst building on our existing market leading Isobar solutions.

The benefits can be found in our new;

- Wireless RCBO solution
- Full IP2X internal protection
- Enhanced wiring space
- Full compatibility with our existing Acti9 Isobar devices and accessories
- 5year product warranty registration



EcoStruxure™

Innovation At Every Level

From sensors to services, our Innovation At Every Level approach improves energy and operational efficiency by tapping the true business value of IoT advancements. We've made mobility, sensing, cloud, analytics, and cyber security technologies meaningful to customers, helping them compete in our IoT economy.

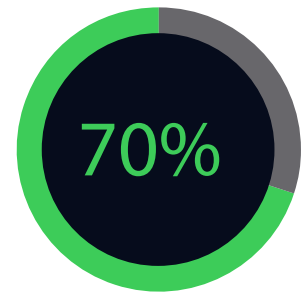

of decision-makers see the business value of IoT*

*Schneider Electric IoT 2020 Business Report

Connected Products:

The Internet of Things starts with the best things. Our IoT-enabled best-in-class connected products include breakers, drives, UPSs, relays, sensors, and more. Devices with embedded intelligence drive better decision-making throughout operations.

Edge Control:

Mission-critical scenarios can be unpredictable, so control of devices at the edge of the IoT network is a must. This essential capability provides real-time solutions that enable local control at the edge, protecting safety and uptime.

Applications, Analytics, and Services:

Interoperability is imperative to supporting the diverse hardware and systems in building, data center, industry, and grid end markets. EcoStruxure™ enables a breadth of agnostic applications, analytics, and services for seamless enterprise integration.

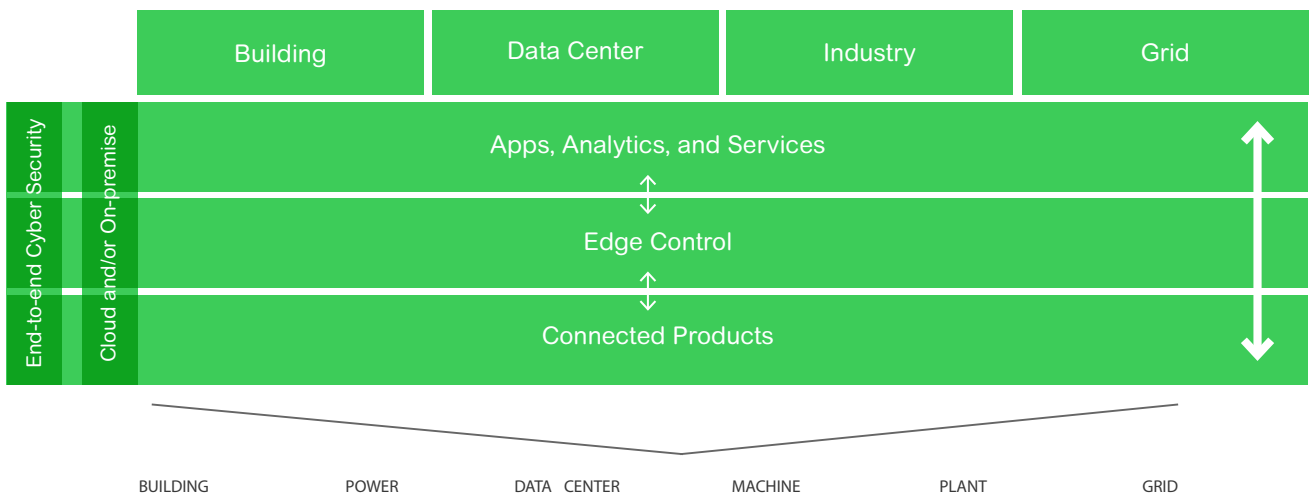

Connectivity built in

Acti9 Isobar P harnesses the connectivity of the Acti9 range enabling distribution boards to become smart and connected.



1. Enable asset management through a new wireless RCBO PowerTag



2. Enable asset management on all outgoing ways with PowerTag



3. PowerTag link for wireless data concentration



4. Enable further asset and energy management through PowerTag for Compact NSX



5. Monitor and control your assets with SiB Smartlink



6. See the power and optimise the use of your assets with Facility Expert our simple on-line services platform

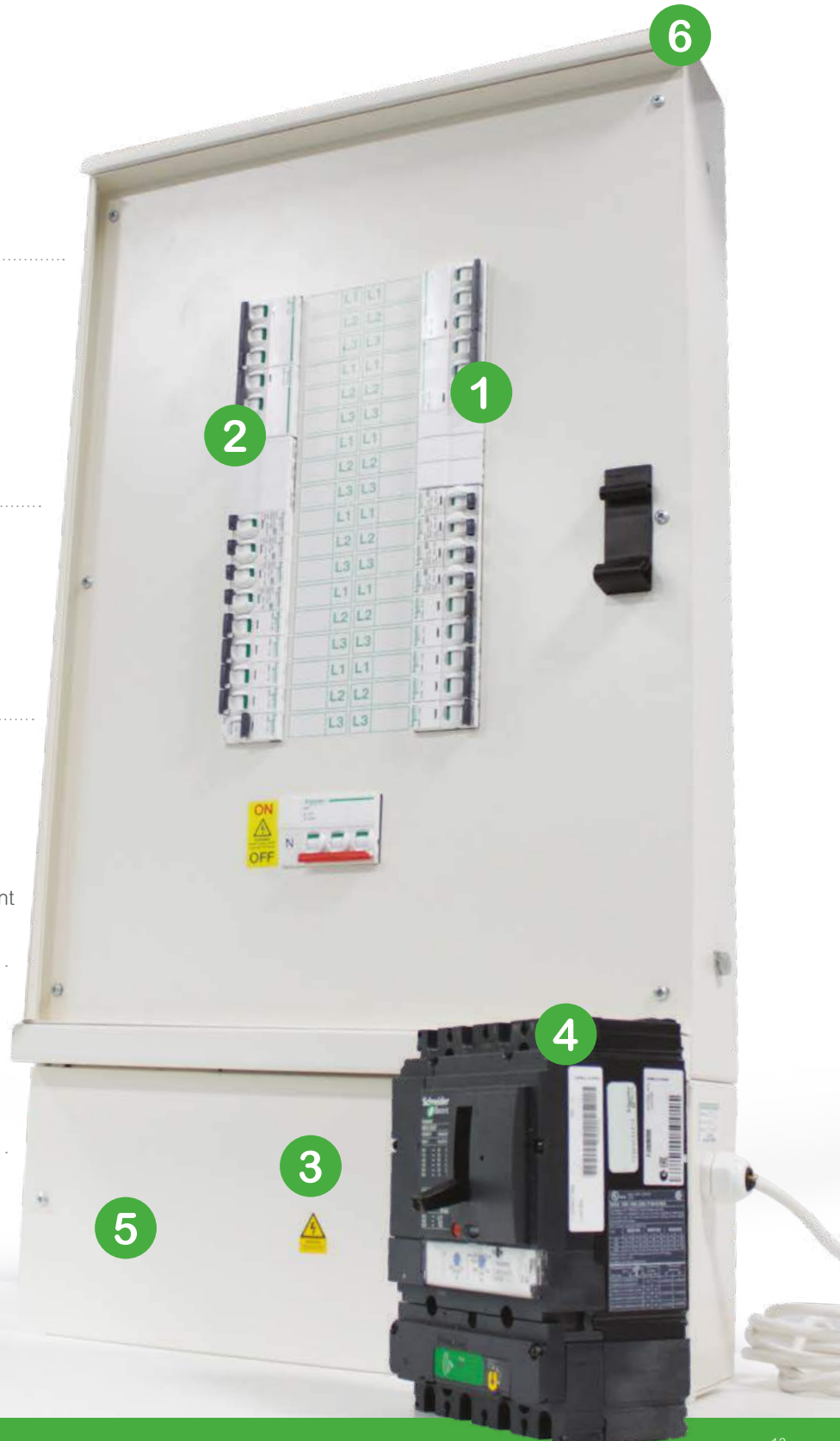



What's new with Acti9 IsoBar P?

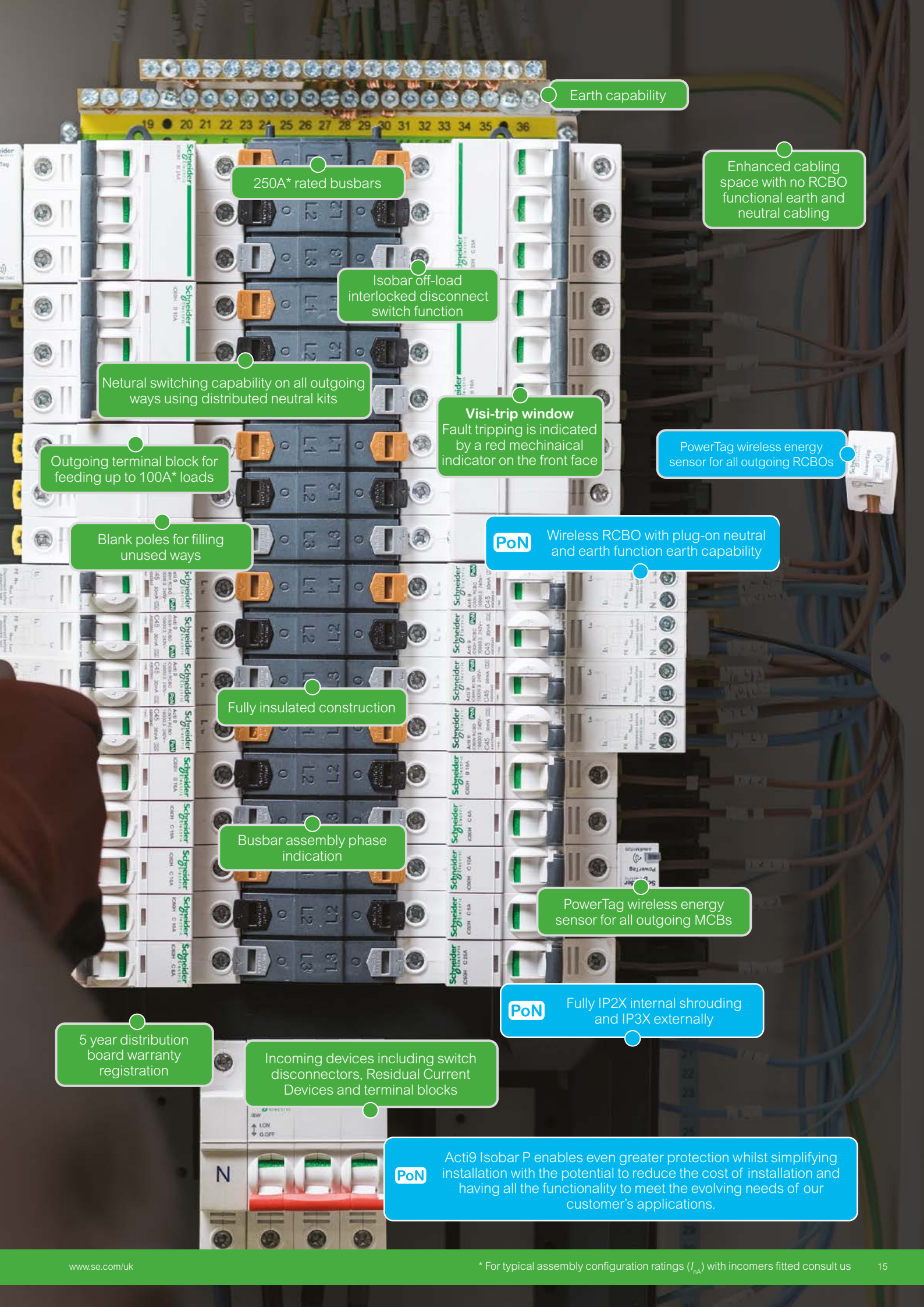

Earth capability

250A* rated busbars

Enhanced cabling space with no RCBO functional earth and neutral cabling

Isobar off-load interlocked disconnect switch function

Neutral switching capability on all outgoing ways using distributed neutral kits

Visi-trip window
Fault tripping is indicated by a red mechanical indicator on the front face

PowerTag wireless energy sensor for all outgoing RCBOs

Outgoing terminal block for feeding up to 100A* loads

Blank poles for filling unused ways

PoN Wireless RCBO with plug-on neutral and earth function earth capability

Fully insulated construction

Busbar assembly phase indication

PowerTag wireless energy sensor for all outgoing MCBs

5 year distribution board warranty registration

Incoming devices including switch disconnectors, Residual Current Devices and terminal blocks

PoN Fully IP2X internal shrouding and IP3X externally

PoN Acti9 Isobar P enables even greater protection whilst simplifying installation with the potential to reduce the cost of installation and having all the functionality to meet the evolving needs of our customer's applications.

A man with short brown hair and a light beard, wearing a dark blue polo shirt, is looking down at a tablet computer he is holding with both hands. He has a slight smile. In the background, there is a server rack with various cables (blue, orange, yellow) plugged into it. The scene is lit with soft, natural light.

Acti9 Isobar P

A type distribution boards

Single Phase Distribution

Definition

Single Phase distribution board – A single phase assembly containing switching or protective devices (e.g. circuit breakers and residual current operator devices) associated with one or more outgoing circuits fed from one or more incoming circuits, together with terminals for the neutral and circuit protective conductors. It may also include signalling and other control devices.

Key standards

- BSEN 61439 – 3 Low Voltage Switchgear and Controlgear Assemblies
- BSEN 60898 – 1 Electrical accessories - Circuit breakers for overcurrent protection for household and similar installations - Circuit breakers for a.c. operation
- BSEN 61009 – 1 Residual Current Circuit Breaker with Overcurrent Protection
- BSEN 61008 – 1 Specification for residual current operated circuit breakers without integral overcurrent protection for household and similar uses (RCCBs). General rules
- BSEN 60947 - 2 Low Voltage switchgear and controlgear. Circuit breakers

Applications

Final circuit single phase or single phase and neutral low voltage distribution, typical loads serviced;

Lighting, Power, IT, HVAC, Critical Power

Generally supplied by a panel board or three phase distribution board, systems are designed to ensure supply continuity “discrimination” and enhanced performance “cascading”.

Typical infrastructure layout

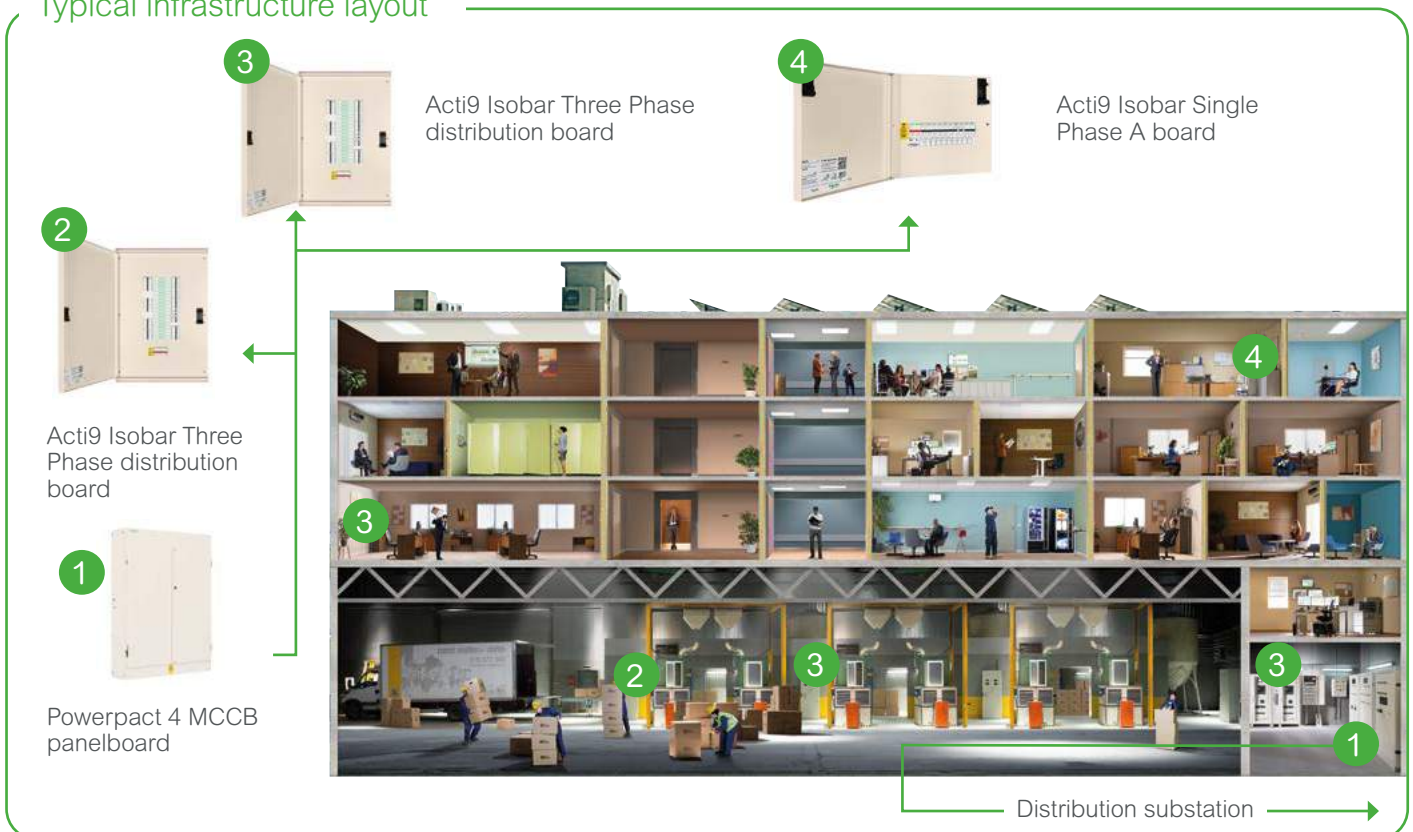

Distribution Board

Incomer

Outgoing Devices

Complimentary Devices

Accessories

Connectivity

Acti9 Isobar P single phase A type distribution boards (125A)*

Standard Acti9 Isobar P 'A' Type distribution board

The Acti9 Isobar P distribution boards are suitable for standard, commercial and industrial applications.



SEA9APN10

Part reference	No of Single Pole Ways
SEA9APN2	2
SEA9APN6	6
SEA9APN10	10
SEA9APN14	14
SEA9APN18	18
SEA9APN27	27

PoN

Multi Service Acti9 Isobar P distribution boards

The Acti9 Isobar P Multi Service Board has the added benefit of the inclusion of din rail modular devices if required



SEA9APN1016MS

Part reference	No of Single Pole Ways	No of Usable Single pole Din Rails Ways
SEA9APN108MS	10	4
SEA9APN1432MS	14	16
SEA9APN616MS	6	8
SEA9APN624MS	6	12
SEA9APN148MS	14	4
SEA9APN1016MS	10	8

PoN

Split Metered Acti9 Isobar P distribution boards

Acti9 isobar split metered distribution board for use when the metering of final circuits may be required Incoming switch disconnecter is included



SEA9APN10S10

Part reference	No of Single Pole Ways	No of Single Pole Ways
SEA9APN6S6 (Inc Meter A9MEM2010)	6	6
SEA9APN10S10 (Inc Meter A9MEM2015)	10	10
SEA9APN14S14 (Inc Meter A9MEM2105)	14	14

PoN

- The split metered board has a busbar rating of 100amps.
- The total load for 2 rows is 50A per row. 1 row is 40A per split.



Acti9 Isobar P single phase incoming devices

Switch disconnectors



SEA91252

Part reference	Rating	No of Poles
SEA91252	125Amps	2

- 50mm² cable capacity

Residual Current Circuit Breakers (Type AC)



SEA9R11291

Part Reference	Rating in Amps	Rating in Milliamps (mA) sensitivity
SEA9R41263	63	30
SEA9R12263	63	100
SEA9R44263	63	300
SEA9R11280	80	30
SEA9R12280	80	100
SEA9R14280	80	300
SEA9R15280	80	300 TD (Time Delay)
SEA9R11291	100	30
SEA9R12291	100	100
SEA9R14291	100	300
SEA9R15291	100	300 TD (Time Delay)

Connections - terminals

- Single terminal top or bottom 1...35mm² rigid
- Single terminal top or bottom 1...25mm² flexible
- Single terminal top or bottom 1...25mm² flexible with ferrule

Terminal Blocks - suitable for direct connection



SEA9TB1252

Part Reference	Ratings in Amps	No of Poles
SEA9TB1252	125Amps	2

- 50mm² cable capacity

Acti9 iC60H Circuit Breaker

Acti9 iC60H circuit breaker

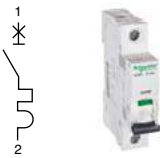
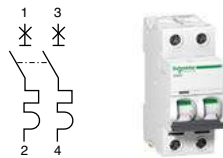
Type	1P			2P		
						
Current Rating (In)	Curve			Curve		
	B	C	D	B	C	D
1 A	A9F53101	A9F54101	A9F55101	A9F53201	A9F54201	A9F55201
2 A	A9F53102	A9F54102	A9F55102	A9F53202	A9F54202	A9F55202
3 A	A9F53103	-	-	-	-	-
4 A	A9F53104	A9F54104	A9F55104	A9F53204	A9F54204	A9F55204
6 A	A9F53106	A9F54106	A9F55106	A9F53206	A9F54206	A9F55206
10 A	A9F53110	A9F54110	A9F55110	A9F53210	A9F54210	A9F55210
16 A	A9F53116	A9F54116	A9F55116	A9F53216	A9F54216	A9F55216
20 A	A9F53120	A9F54120	A9F55120	A9F53220	A9F54220	A9F55220
25 A	A9F53125	A9F54125	A9F55125	A9F53225	A9F54225	A9F55225
32 A	A9F53132	A9F54132	A9F55132	A9F53232	A9F54232	A9F55232
40 A	A9F53140	A9F54140	A9F55140	A9F53240	A9F54240	A9F55240
50 A	A9F53150	A9F54150	A9F55150	A9F53250	A9F54250	A9F55250
63 A	A9F53163	A9F54163	A9F55163	A9F53263	A9F54263	A9F55263
Width in 9-mm modules	2			4		

Alternating current (AC) 50/60 Hz					
Breaking capacity (Icu) according to IEC/EN 60947-2					
		Voltage (Ue)			
Ph/Ph (2P, 3P, 4P)		12 to 133 V	220 to 240 V	380 to 415 V	440 V
Ph/N (1P)		12 to 60 V	100 to 133 V	220 to 240 V	-
Rating (In)	1 to 4 A	70 kA	70 kA	70 kA	50 kA
	6 to 40 A	42 kA	30 kA	15 kA	10 kA
	50/63 A	42 kA	-	15 kA	10 kA
Breaking capacity (Icn) according to IEC/EN 60898-1					
Current Rating (In)		Voltage (Ue)	(Icn)		
1 to 63 A		Ph/Ph 400 V	10000 A		
1 to 63 A		Ph/N 230 V	10000 A		
Direct current (DC)					
Breaking capacity (Icu) according to IEC/EN 60947-2					
	Voltage (Ue)				
Between +/-	12 to 48 V	72 V	100 to 133 V		220 to 250 V
Number of poles	1P		2P (in series)	3P (in series)	4P (in series)
Rating (In) 1 to 63 A	20 kA	10 kA	10 kA	20 kA	10 kA

Acti9 iC60H PoN RCBO's 10,30 and 100mA

Acti9 iC60H Plug-on Residual Current Circuit Breaker with Overload

B Curve



A9D56832

A Type

B Curve	Rating in amps	Sensitivity rating in milliamps (mA)
A9D56806	6A	30mA
A9D56810	10A	30mA
A9D56816	16A	30mA
A9D56820	20A	30mA
A9D56825	25A	30mA
A9D56832	32A	30mA
A9D56840	40A	30mA
A9D56845	45A	30mA

PoN

C Curve



A9D05832

A Type

C Curve	Rating in amps	Sensitivity rating in milliamps (mA)
A9D01806	6A	10mA
A9D01810	10A	10mA
A9D01816	16A	10mA
A9D01820	20A	10mA
A9D01825	25A	10mA
A9D01832	32A	10mA
A9D01840	40A	10mA
A9D01845	45A	10mA
<hr/>		
A9D05806	6A	30mA
A9D05810	10A	30mA
A9D05816	16A	30mA
A9D05820	20A	30mA
A9D05825	25A	30mA
A9D05832	32A	30mA
A9D05840	40A	30mA
A9D05845	45A	30mA
<hr/>		
A9D06806	6A	100mA
A9D06810	10A	100mA
A9D06816	16A	100mA
A9D06820	20A	100mA
A9D06825	25A	100mA
A9D06832	32A	100mA
A9D06840	40A	100mA
A9D06845	45A	100mA

PoN

PoN

PoN

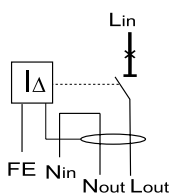

Alternating current (AC) 50/60 Hz		
Breaking capacity (Icn) according to IEC/EN 61009-1		
Current Rating (In)	Voltage (Ue)	(Icn)
6 to 45 A	Ph/N 240 V	10000A
10 to 32 A	Ph/N 110 V	10000A

Acti9 iC60H RCBO 10,30 and 100mA

Acti9 iC60H Residual Current Circuit Breaker with Overload

B Curve



A Type

B Curve	Rating in amps	Sensitivity rating in milliamps (mA)
A9D31806	6A	30mA
A9D31810	10A	30mA
A9D31816	16A	30mA
A9D31820	20A	30mA
A9D31825	25A	30mA
A9D31832	32A	30mA
A9D31840	40A	30mA
A9D31845	45A	30mA

C Curve



A Type

C Curve	Rating in amps	Sensitivity rating in milliamps (mA)
A9D10806	6A	10mA
A9D10810	10A	10mA
A9D10816	16A	10mA
A9D10820	20A	10mA
A9D10825	25A	10mA
A9D10832	32A	10mA
A9D10840	40A	10mA
A9D10845	45A	10mA
<hr/>		
A9D11806	6A	30mA
A9D11810	10A	30mA
A9D11816	16A	30mA
A9D11820	20A	30mA
A9D11825	25A	30mA
A9D11832	32A	30mA
A9D11840	40A	30mA
A9D11845	45A	30mA
<hr/>		
A9D12806	6A	100mA
A9D12810	10A	100mA
A9D12816	16A	100mA
A9D12820	20A	100mA
A9D12825	25A	100mA
A9D12832	32A	100mA
A9D12840	40A	100mA
A9D12845	45A	100mA



Acti9 iC60H RCBO 110V (Ph/N) 30mA

Acti9 iC60H Residual Current Circuit Breaker with Overload

C Curve



A9D19832

C Curve	Rating in amps	Sensitivity rating in milliamps (mA)	Rating in volts
A9D19810	10A	30mA	110V
A9D19816	16A	30mA	110V
A9D19820	20A	30mA	110V
A9D19825	25A	30mA	110V
A9D19832	32A	30mA	110V

Alternating current (AC) 50/60 Hz		
Breaking capacity (Icn) according to IEC/EN 61009-1		
Current Rating (In)	Voltage (Ue)	(Icn)
10 to 32 A	Ph/N 110 V	10000A

Vigi iC60 add-on residual current devices



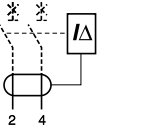

A9V02663

Vigi iC60 add-on residual current devices									
Type	A 							Width in 9 mm modules	
Product	Vigi iC60								
Auxiliaries		Without auxiliaries							
1P+N	Rating	Sensitivity	30 mA	100 mA	300 mA				
	25 A							3	
	63 A		A9V02663 A9V01663*	A9V03663	A9V06663			4	
Voltage rating (Ue)		230 - 240 V, 400 - 415 V Except * 110 V							
Operating frequency		50/60 Hz							



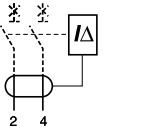

A9V51225

Vigi iC60 add-on residual current devices									
Type	A 							Width in 9 mm modules	
Product	Vigi iC60								
Auxiliaries		Without auxiliaries							
2P	Rating	Sensitivity	30 mA	100 mA	300 mA	500 mA	300 mA 	1000 mA 	
	25 A		A9V51225	A9V22225	A9V54225	A9V26225	-	-	3
	63 A		A9V51263	A9V22263	A9V54263	A9V26263	A9V25263	A9V29263	4
Voltage rating (Ue)		230 - 240 V, 400 - 415 V							
Operating frequency		50/60 Hz							

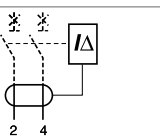

A9V61240

Vigi iC60 add-on residual current devices									
Type	SI 							Width in 9 mm modules	
Product	Vigi iC60								
Auxiliaries		Without auxiliaries							
2P	Rating	Sensitivity	10 mA	30 mA	300 mA 	1000 mA 			
	25 A		A9V30225	A9V61225	-	-		3	
	40 A		-	A9V61240	-	-		4	
	63 A		-	A9V61263	A9V65263	A9V39263		4	
Voltage rating (Ue)		230 - 240 V, 400 - 415 V							
Operating frequency		50/60 Hz							

Protection / Circuit protection

Arc fault detection device iARC



BS EN 62606

General requirements for arc fault detection devices.

iARC is an arc fault detection device which aims to reduce the risk of electrical fire. By continuously analysing a large number of electrical parameters, it detects the appearance of electric arcs that are responsible for starting fires. It isolates the circuit concerned, which reduces flame appearance occurrence.

Regulation 421.1.7 of BS 7671: 2018 (IET Wiring Regulations 18th Edition) recommends the use of AFDD to protect against arc fault in AC final circuits. Examples of where AFDDs can be used include:

- premises with sleeping accommodations (e.g., hotels, nursing homes, dwellings)
- locations with a risk of fire due to the nature of processed or stored materials (e.g., barns, wood-working shops, stores of combustible materials)
- locations with combustible constructional materials (e.g., wooden buildings)
- fire propagating structures (e.g. high rise buildings)
- locations where irreplaceable goods are housed (e.g., museums).



iARC must not be installed on circuits requiring a high level of continuity of service.

Regulation 710.421.1.201 of BS 7671: 2018 states that AFDDs are not required to be installed in medical locations of Group 1 and 2, and that in medical locations of Group 0 they shall be used subject to a risk assessment.

iARC is not compatible with ATEX regulations

Catalogue numbers

iARC			
Arc Fault Detection Device (AFDD) to BS EN 62606			Width in 9 mm modules
1P+N			
	Rating 32 A (In)	A9FDD232	4
Operating voltage	230 V AC		
Operating frequency	50 Hz		

Connection

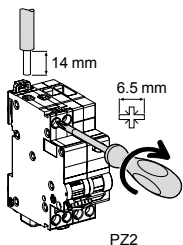

Tightening torque	Copper cables only	
	Rigid	Flexible or with ferrule
2 N.m	1 x 1 to 16 mm ² 2 x 1 to 2.5 mm ²	1 x 1 to 10 mm ² 2 x 1 to 2.5 mm ²

- iARC protects against hazardous electric arc faults that can occur in damaged cables and loose electrical connections that may create intense overheating which could eventually lead to a fire.
- It can provide protection from the following hazardous arc faults that could lead to a fire
- Parallel arc fault: arc fault resulting from damaged insulation between two live conductors or a live conductor and earth in cables or connected equipment that causes a fault current too low to operate protective devices such as fuses or MCBs.
- Series arc fault: arc fault resulting from damaged (crushed or broken) conductor or loose electrical connection in cables or connected equipment in series with a load that causes a fault current too low to operate protective devices such as a fuse or MCB.

It combines the following functions:

- Protection against hazardous arc faults that could lead to a fire
- Circuit opening and positive break indication (green strip)
- Fire hazard tripping indication via the front panel indicator
- Device self-diagnostics via the test button
- Installed in series with a MCB or an RCBO, max 32A, it protects line-to-neutral or line-line circuits, in full coordination under short-circuit conditions up to a rated breaking capacity (I_{cn}) of 10,000 A.

Complimentary Devices

Acti9 IID 2P B EV RCCB



A9Z51240

Reference	Description	Type	Rating in amps	Sensitivity rating in milliamps (mA)	Width in 9mm modules
A9Z51225	ACT19 IID 2P 25A 30MA B EV RCCB	EV RCCB	25	30	8
A9Z51240	ACT19 IID 2P 40A 30MA B EV RCCB	EV RCCB	40	30	8

Acti9 IID 2P B-SI RCCB



A9Z61225

Reference	Description	Type	Rating in amps	Sensitivity rating in milliamps (mA)	Width in 9mm modules
A9Z61225	ACT19 IID 2P 25A 30MA B-SI RCCB	Standard	25	30	8
A9Z61240	ACT19 IID 2P 40A 30MA B-SI RCCB	Standard	40	30	8
A9Z61263	ACT19 IID 2P 63A 30MA B-SI RCCB	Standard	63	30	8
A9Z64225	ACT19 IID 2P 25A 300MA B-SI RCCB	Standard	25	300	8
A9Z64240	ACT19 IID 2P 40A 300MA B-SI RCCB	Standard	40	300	8
A9Z64263	ACT19 IID 2P 63A 300MA B-SI RCCB	Standard	63	300	8

RCD types

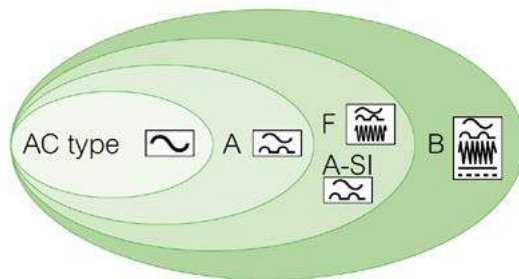

Distribution Board

Incomer

Outgoing Devices

Complimentary Devices

Accessories

Connectivity

Acti9 Isobar P single phase Accessories

General accessories



SEA9BL

Part Reference	Description
SEA9BL	Door Lock
SEA9PD	Padlock Kit for Door
SEA9BP	Blank Pole
SEA9BP3	Single 3 Pole filler
SEA9TB1001	100amp 1 pole terminal block
SEA9ANWL	SP&N Labels
SEA9FCF	Pack of 24 fixing screws
SEK33	Spare keys

Distributed neutral kits



SEA9NA27

Part reference	Description	No of Ways
SEA9NA6	Distributed neutral kit for 6way SP&N	6
SEA9NA10	Distributed neutral kit for 10way SP&N	10
SEA9NA14	Distributed neutral kit for 14way SP&N	14
SEA9NA18	Distributed neutral kit for 18way SP&N	18
SEA9NA27	Distributed neutral kit for 27way SP&N	27
SEA9NKIT	Phase to Neutral conversion kit (pack of 4, distributed neutral kit also required)	

- This kit allows you to distribute and control the neutral through the board for 4 outgoing circuits.

Flush mounting kits

Flush mounted kits are used to allow recessing of distribution boards into the building structure



SEA9AN10FK

Part Reference	Description	No of Ways	Dimensions same as
SEA9AN6FK	Flush Mounting Kit	6	SEA9AN6
SEA9AN10FK	Flush Mounting Kit	10	SEA9AN10
SEA9AN14FK	Flush Mounting Kit	14	SEA9AN14
SEA9AN18FK	Flush Mounting Kit	18	SEA9AN18

Spare doors and covers



SEA9AN10C

Part Reference	Description
SEA9AN6C	6 Way Door and Cover
SEA9AN10C	10 Way Door and Cover
SEA9AN14C	14 Way Door and Cover
SEA9AN18C	18 Way Door and Cover
SEA9AN27C	27 Way Door and Cover

DIN rail enclosures



SEA9DE40

Part Reference	Description	Number of rows	Dimensions same as
SEA9DE16	8 SP way module enclosure	1	SEA9AN6
SEA9DE24	12 SP way module enclosure	1	SEA9AN10
SEA9DE32	16 SP way module enclosure	1	SEA9AN14
SEA9DE40	20 SP way module enclosure	1	SEA9AN18
SEA9DE64	32 SP way module enclosure	2	SEA9AN27



Acti9 Isobar P and AFDD Arrangements

A Type multi service distribution boards provide an additional DIN rail to accommodate devices such as Contactors, SPD and AFDD.

DIN rail enclosures can also be used in addition to standard A Type distribution boards to accommodate devices such as Contactors, SPD and AFDD.

Acti9 Multi service boards or din rail Enclosure

Multi Service Boards

or

Acti9 din rail Enclosure

Acti9 Isobar P single phase A type Multi Service boards



DIN rail enclosures



or

Part reference	No of Single Pole Ways	No of Usable Single pole Din	No of AFDD (A9FDD232)
SEA9APN108MS	10	4	2
SEA9APN1432MS	14	16	8
SEA9APN616MS	6	8	4
SEA9APN624MS	6	12	6
SEA9APN148MS	14	4	2
SEA9APN1016MS	10	8	4

Part Reference	Description	Number of rows	Dimensions same as	No of AFDD (A9FDD232)
SEA9DE16	8 SP way module enclosure	1	SEA9AN6	4
SEA9DE24	12 SP way module enclosure	1	SEA9AN10	6
SEA9DE32	16 SP way module enclosure	1	SEA9AN14	16
SEA9DE40	20 SP way module enclosure	1	SEA9AN18	10
SEA9DE64	32 SP way module enclosure	2	SEA9AN27	16

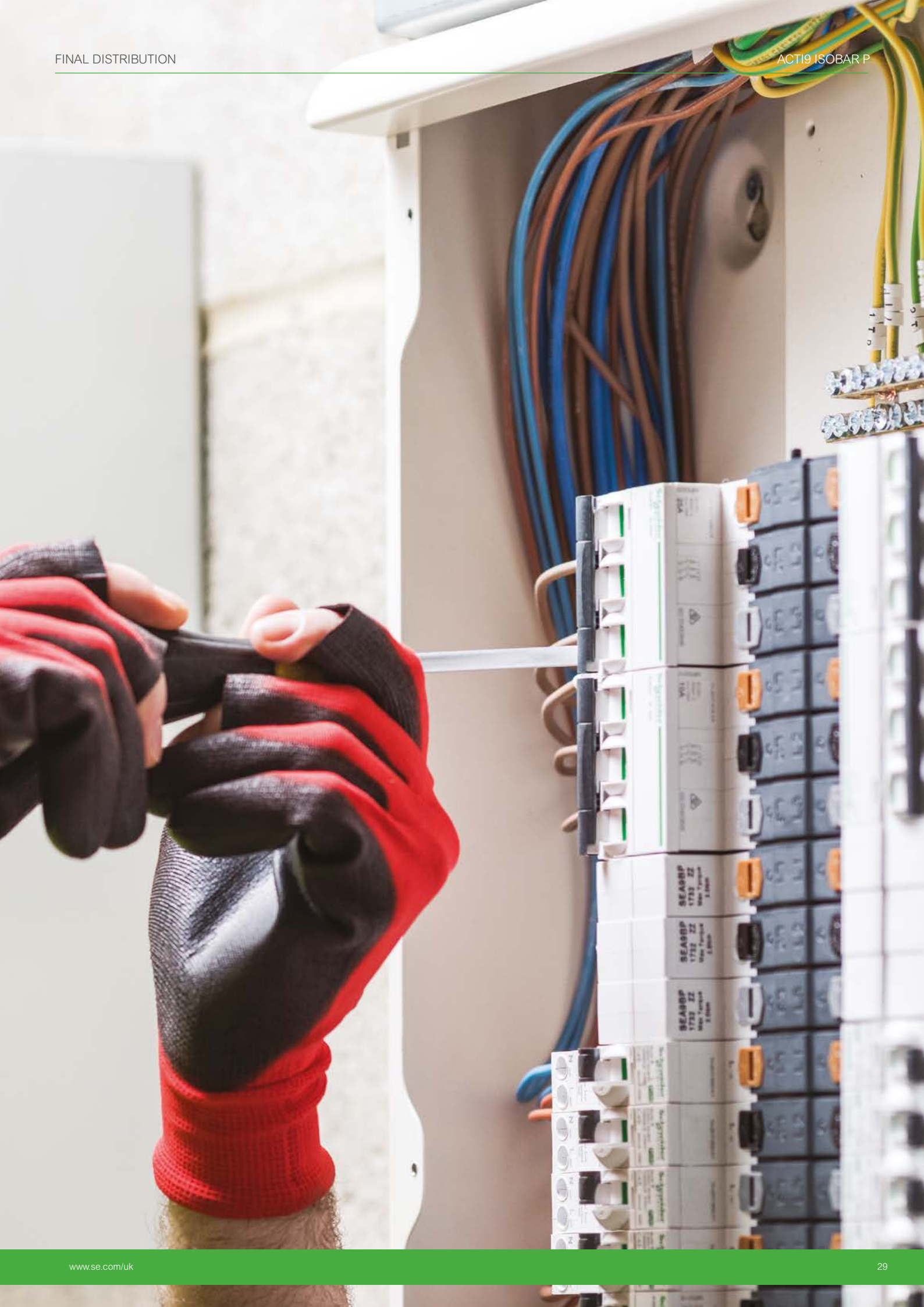



Acti9 Isobar P

B type distribution boards

Three Phase Distribution

Definition

Three Phase distribution board – A three phase assembly containing switching or protective devices (e.g. circuit breakers and residual current operator devices) associated with one or more outgoing circuits fed from one or more incoming circuits, together with terminals for the neutral and circuit protective conductors. It may also include signalling and other control devices.

Key standards

- BSEN 61439 – 3 Low voltage switchgear and controlgear assemblies
- BSEN 60898 – 1 Electrical accessories - circuit breakers for overcurrent protection for household and similar installations - circuit breakers for a.c. operation
- BSEN 61009 – 1 Residual Current Circuit Breaker with Overcurrent protection
- BSEN 61008 – 1 Specification for residual current operated circuit breakers without integral overcurrent protection for household and similar uses (RCCBs). General rules
- BSEN 60947 - 2 Low voltage switchgear and controlgear. Circuit breakers

Applications

Final circuit single phase or single phase and neutral low voltage distribution, typical loads serviced;

Motors, General Power, HVAC, Critical Power

Generally supplied by a panel board or switchboard, systems are designed to ensure supply continuity "discrimination" and enhanced performance "cascading".

Typical infrastructure layout

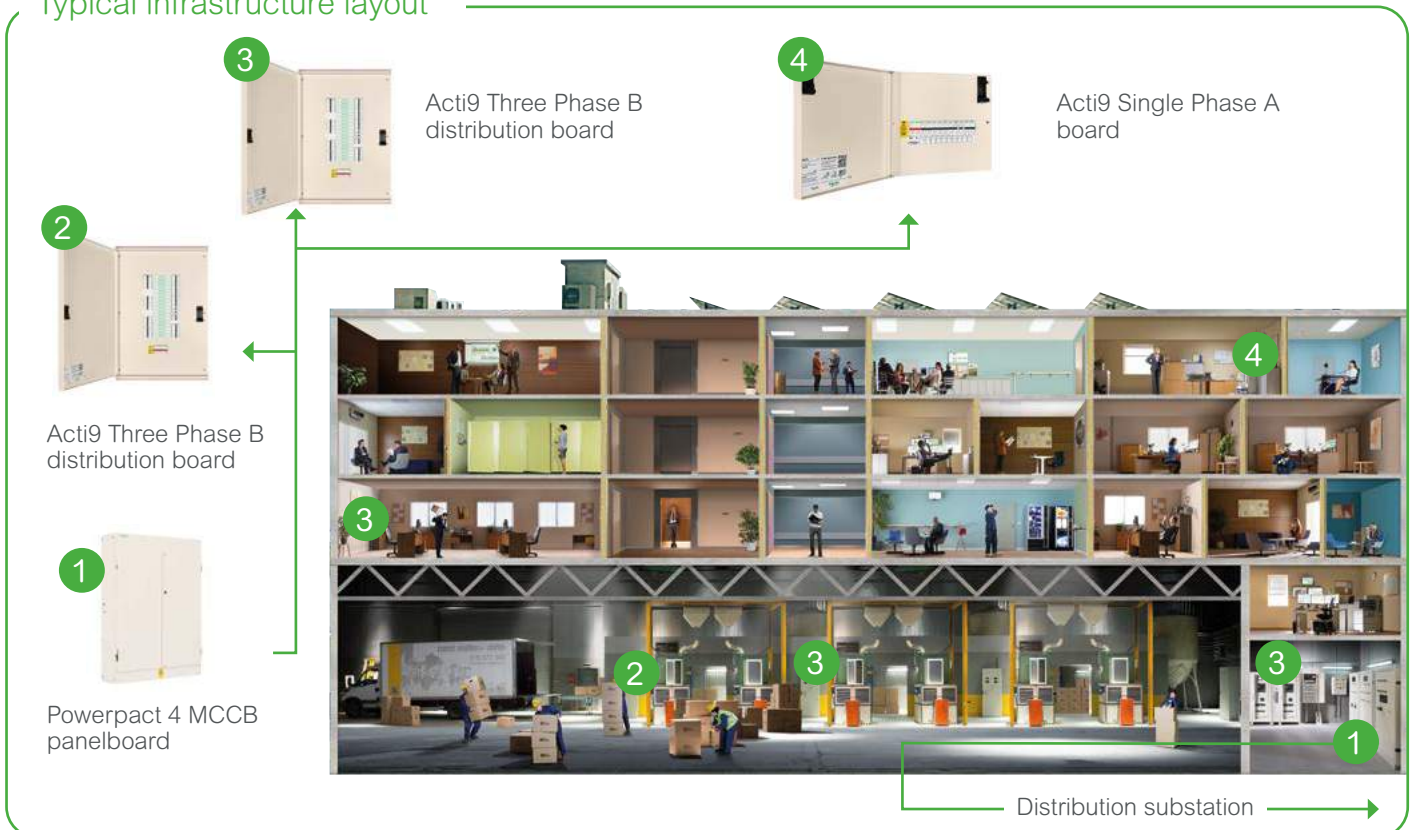

Distribution Board

Incomer

Outgoing Devices

Complimentary Devices

Accessories

Connectivity

Acti9 Isobar P three phase B type distribution board*

Standard Acti9 Isobar P 'B' type distribution boards

The Acti9 Isobar P distribution boards are suitable for standard, commercial and industrial applications.

PoN



SEA9BPN12

Part reference	No of Triple Pole Ways
SEA9BPN4	4
SEA9BPN6	6
SEA9BPN8	8
SEA9BPN12	12
SEA9BPN16	16
SEA9BPN18	18
SEA9BPN24	24

Meter Ready Acti9 Isobar P 'B' type distribution boards

(Incoming 125A TP&N switch disconnecter included)

The Acti9 Isobar P meter ready distribution boards are suitable for standard, commercial and industrial applications and enabled for an incoming meter connection*.

PoN



SEA9BPN12M

Part reference	No of Triple Pole Ways
SEA9BPN6M	6
SEA9BPN8M	8
SEA9BPN12M	12
SEA9BPN16M	16
SEA9BPN18M	18
SEA9BPN24M	24

*See metering kit options

Metering kits

Metering kits are for the addition of incoming metering to an Acti9 standard Isobar P or meter ready Isobar P distribution board.

The kit includes a meter / extension box and the type of connection.



SEA9BNKWH

Part reference	Description	Rating	Connection
Metering Kit for a Standard Board			
SEA9BNKWH	MID 3 Phase kWh kit Modbus communications and Pulsed output (Includes A9MEM3255)	250 amps	Via CT (Included)
SEA9BNKWHP	MID 3 Phase kWh kit Pulsed output (Includes A9MEM3210)	250 amps	Via CT (Included)
SEA9BNMETE	Metering Enclosure for Standard Acti9 Isobar Boards for PM Meters (Meter not included)	250 amps	Via CT (Included)
Metering Kit for a Meter Ready Board			
SEA9BN3155	MID 3 Phase kWh kit Modbus communications (Includes A9MEM3155)	63 amps	Direct
SEA9BN3110	MID 3 phase kWh kit pulsed output (Includes A9MEM3110)	63 amps	Direct
SEA9BN3255	MID 3 phase kWh kit modbus communications (Includes A9MEM3255)	125 amps	Via CT (Included)
SEA9BN3210	MID 3 phase kWh kit pulsed output (Includes A9MEM3210)	125 amps	Via CT (Included)



Split Metered Acti9 Isobar P 'B' type distribution boards (busbar rating 125A) 125A switch disconnecter fitted



The Acti9 Isobar P split meter distribution boards are suitable for standard, commercial and industrial applications and include a 125A switch disconnecter incomer and MID meters with communications (meters included are 2 A9MEM3255)



SEA9BPN12514S8

Part reference	No of Triple Pole Ways	Upper pan assembly No of Triple Pole Ways
SEA9BPN1258S8	8	8
SEA9BPN12514S8	14	8
SEA9BPN12516S6	16	6
SEA9BPN12518S4	18	4

Split Metered Acti9 Isobar P 'B' type distribution boards (busbar rating 250A) incomer supplied separately



The Acti9 Isobar P split meter distribution boards are suitable for standard, commercial and industrial applications and include MID meters with communications (incomer supplied separately) See Page 27 for suitable incomers. (Meters included are 2 A9MEM3255)



SEA9BPN25012S8

Part reference	No of Triple Pole Ways	Upper pan assembly No of Triple Pole Ways
SEA9BPN2508S8	8	8
SEA9BPN25014S8	14	8
SEA9BPN25016S6	16	6
SEA9BPN25018S4	18	4

Heavy duty Acti9 Isobar P 'B' type distribution boards (steel door)

The Acti9 Isobar P heavy duty distribution board is 125A rated and has IP55 external protection and includes a steel door (no metering options available)



SEA9BPN12HDGR

Part reference	No of triple Pole Ways
SEA9BPN6HDGR	6
SEA9BPN8HDGR	8
SEA9BPN12HDGR	12
SEA9BPN16HDGR	16

Distribution Board

Incomer

Outgoing Devices

Complimentary Devices

Accessories

Connectivity

Incoming devices for Acti9 IsoBar P B Type distribution boards

Switch disconnectors 125A

The Acti9 IsoBar P 125A incoming switch disconnectors can be incorporated directly within the distribution board



SEA91253N

Part reference	Rating	No of Poles
SEA91253N	125A	3P+N
SEA91254	125A	4P

- 50mm² cable capacity

Switch disconnectors 160A to 250A

The Acti9 IsoBar P 160A to 250A incoming switch disconnectors require an extension box (which is supplied with the incomer) and are not compatible with heavy duty distribution boards



SEA9PNI2504

Part Reference	Rating	No of Poles
SEA9PNI1603	160A	3P+N
SEA9PNI1604	160A	4P
SEA9PNI2003	200A	3P+N
SEA9PNI2004	200A	4P
SEA9PNI2254*	225A	4P
SEA9PNI2503	250A	3P+N
SEA9PNI2504	250A	4P

Moulded Circuit Breakers 100A to 250A

The Acti9 IsoBar P 100A to 250A incoming circuit breakers require an extension box (which is supplied with the incomer) and are not compatible with heavy duty distribution boards



SEA9PNCB2504

Part Reference	Rating	No of Poles
SEA9PNCB1004	100A	3P+N
SEA9PNCB1604	160A	4P
SEA9PNCB2004	200A	3P+N
SEA9PNCB2504	250A	4P

Residual Current Circuit Breakers up to 100A

The Acti9 IsoBar P incoming RCDs can be incorporated directly within the distribution board



SEA9R41463

Part Reference	Rating	Rating in Milliamps (mA) sensitivity	No of Poles
SEA9R41463	63A	30	4
SEA9R12463	63A	100	4
SEA9R44463	63A	300	4
SEA9R11480	80A	30	4
SEA9R14491	100A	300	4
SEA9R15491	100A	300 TD (Time Delay)	4



Residual Current Circuit Breakers up to 160A

The Acti9 Isobar P 160A incoming RCDs require an extension box and are not compatible with heavy duty distribution boards



SEA9PNI160RCCB

Part Reference	Rating in Amps	Rating in Milliamps (mA) sensitivity	No of Poles
SEA9PNI160RCCB	160	Adjustable - 30mA, 300mA, 1A, 3A, and 10A	4

Terminal blocks - suitable for direct connection (250A includes extension box)

The Acti9 Isobar P 250A incoming terminal blocks require an extension box and are not compatible with heavy duty distribution boards



SEA9PNTB2504

Part reference	Rating	No of Poles
SEA9PTB1254	125A	4
SEA9PNTB2504	250A	4

Dual Source Incomer - (270mm extension box included)

The Acti9 Isobar P Dual Source Incomer is not compatible with heavy duty distribution boards



SEA9PNDSI

Part reference	Rating	No of Poles
SEA9PNDSI	125A	4

Contactor Incomer - (270mm extension box included)

The Acti9 Isobar P Contactor Incomer is not compatible with Heavy Duty distribution boards



SEA9BN100CCI

Part reference	Rating	No of Poles
SEA9BN100CCI*	100A	4

*not for lighting applications

- Includes, 1 x 100A 4 pole contactor, 4 pole terminal block and 4 pole 125A switch disconnecter

Dual metered extension enclosure including switch disconnecter and MID meters

The Acti9 Isobar P dual metered extension enclosure for use with standard distribution boards and is not compatible with heavy duty distribution boards (Meters included 2 A9MEM3255)



SEA9BNDM250SD

Part reference	Rating	No of Poles
SEA9BNDM160SD	160A	4
SEA9BNDM200SD	200A	4
SEA9BNDM250SD	250A	4

- Requires, 2 x 4P incomers, 2 x distribution boards and 2 x door locks



Dual metered extension enclosure including circuit breakers and MID meters

The Acti9 Isobar P dual metered extension enclosure for use with standard distribution boards and is not compatible with heavy duty distribution boards (Meters included 2 A9MEM3255)



SEA9BNDM250M

Part reference	Rating	No of Poles
SEA9BNDM160M	160A	4
SEA9BNDM200M	200A	4
SEA9BNDM250M	250A	4

Incomers for 250amp split metered boards



SEA9NCB2504SM

Part Reference	Description	Rating	No of Poles
SEA9NCB1604SM	160A 4p MCCB for 250amp Split metered board	160A	4
SEA9NCB2004SM	200A 4p MCCB for 250amp Split metered board	200A	4
SEA9NCB2504SM	250A 4p MCCB for 250amp Split metered board	250A	4
SEA9NI1604SM	160A 4p Switch for 250amp Split metered board	160A	4
SEA9NI2004SM	200A 4p Switch for 250amp Split metered board	200A	4
SEA9NI2504SM	250A 4p Switch for 250amp Split metered board	250A	4

• Incoming device only

Acti9 iC60H Circuit Breaker

A9 F 54 1 32

Range	Family	Code	Internal code	Poles	Code	Rating (A)	Code	
Acti 9 (A9)	iID	R		1P	1	1	01	
	Vigi iC60	V		2P	2	2	02	
	iC60	F		3P	3	3	03	
	iK60	K		4P	4	4	04	
	Auxiliaries and accessories	A					6	06
	Switches	S					8	08
	Reflex iC60	C					10	10
						16	16	
						20	20	
						25	25	
						32	32	
						40	40	
						50	50	
						63	63	

Acti9 iC60H circuit breaker

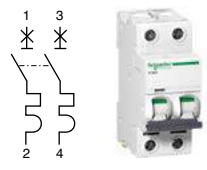
Type	1P			2P		
						
Current rating (In)	Curve			Curve		
	B	C	D	B	C	D
1 A	A9F53101	A9F54101	A9F55101	A9F53201	A9F54201	A9F55201
2 A	A9F53102	A9F54102	A9F55102	A9F53202	A9F54202	A9F55202
3 A	A9F53103	-	-	-	-	-
4 A	A9F53104	A9F54104	A9F55104	A9F53204	A9F54204	A9F55204
6 A	A9F53106	A9F54106	A9F55106	A9F53206	A9F54206	A9F55206
10 A	A9F53110	A9F54110	A9F55110	A9F53210	A9F54210	A9F55210
16 A	A9F53116	A9F54116	A9F55116	A9F53216	A9F54216	A9F55216
20 A	A9F53120	A9F54120	A9F55120	A9F53220	A9F54220	A9F55220
25 A	A9F53125	A9F54125	A9F55125	A9F53225	A9F54225	A9F55225
32 A	A9F53132	A9F54132	A9F55132	A9F53232	A9F54232	A9F55232
40 A	A9F53140	A9F54140	A9F55140	A9F53240	A9F54240	A9F55240
50 A	A9F53150	A9F54150	A9F55150	A9F53250	A9F54250	A9F55250
63 A	A9F53163	A9F54163	A9F55163	A9F53263	A9F54263	A9F55263
Width in 9-mm modules	2			4		



Current rating (In)	3P Curve			4P Curve		
	B	C	D	B	C	D
1 A	A9F53301	A9F54301	A9F55301	A9F53401	A9F54401	A9F55401
2 A	A9F53302	A9F54302	A9F55302	A9F53402	A9F54402	A9F55402
3 A	-	-	-	-	-	-
4 A	A9F53304	A9F54304	A9F55304	A9F53404	A9F54404	A9F55404
6 A	A9F53306	A9F54306	A9F55306	A9F53406	A9F54406	A9F55406
10 A	A9F53310	A9F54310	A9F55310	A9F53410	A9F54410	A9F55410
16 A	A9F53316	A9F54316	A9F55316	A9F53416	A9F54416	A9F55416
20 A	A9F53320	A9F54320	A9F55320	A9F53420	A9F54420	A9F55420
25 A	A9F53325	A9F54325	A9F55325	A9F53425	A9F54425	A9F55425
32 A	A9F53332	A9F54332	A9F55332	A9F53432	A9F54432	A9F55432
40 A	A9F53340	A9F54340	A9F55340	A9F53440	A9F54440	A9F55440
50 A	A9F53350	A9F54350	A9F55350	A9F53450	A9F54450	A9F55450
63 A	A9F53363	A9F54363	A9F55363	A9F53463	A9F54463	A9F55463
Width in 9-mm modules	6			8		

Alternating current (AC) 50/60 Hz					
Breaking capacity (Icu) according to IEC/EN 60947-2					
		Voltage (Ue)			
Ph/Ph (2P, 3P, 4P)		12 to 133 V	220 to 240 V	380 to 415 V	440 V
Ph/N (1P)		12 to 60 V	100 to 133 V	220 to 240 V	-
Rating (In)	1 to 4 A	70 kA	70 kA	70 kA	50 kA
	6 to 40 A	42 kA	30 kA	15 kA	10 kA
	50/63 A	42 kA	-	15 kA	10 kA
Breaking capacity (Icn) according to IEC/EN 60898-1					
Current Rating (In)		Voltage (Ue)	(Icn)		
1 to 63 A		Ph/Ph 400 V	10000 A		
1 to 63 A		Ph/N 230 V	10000 A		
Direct current (DC)					
Breaking capacity (Icu) according to IEC/EN 60947-2					
		Voltage (Ue)			
Between +/-	12 to 48 V	72 V	100 to 133 V		220 to 250 V
Number of poles	1P		2P (in series)	3P (in series)	4P (in series)
Rating (In) 1 to 63 A	20 kA	10 kA	10 kA	20 kA	10 kA

Acti9 iC60H PoN RCBO's 10,30 and 100mA

Acti9 iC60H Plug-on Residual Current Circuit Breaker with Overload

B Curve



A9D56832

A Type

B Curve	Rating in amps	Sensitivity rating in milliamps (mA)
A9D56806	6A	30mA
A9D56810	10A	30mA
A9D56816	16A	30mA
A9D56820	20A	30mA
A9D56825	25A	30mA
A9D56832	32A	30mA
A9D56840	40A	30mA
A9D56845	45A	30mA

PoN

C Curve



A9D05832

A Type

C Curve	Rating in amps	Sensitivity rating in milliamps (mA)
A9D01806	6A	10mA
A9D01810	10A	10mA
A9D01816	16A	10mA
A9D01820	20A	10mA
A9D01825	25A	10mA
A9D01832	32A	10mA
A9D01840	40A	10mA
A9D01845	45A	10mA
<hr/>		
A9D05806	6A	30mA
A9D05810	10A	30mA
A9D05816	16A	30mA
A9D05820	20A	30mA
A9D05825	25A	30mA
A9D05832	32A	30mA
A9D05840	40A	30mA
A9D05845	45A	30mA
<hr/>		
A9D06806	6A	100mA
A9D06810	10A	100mA
A9D06816	16A	100mA
A9D06820	20A	100mA
A9D06825	25A	100mA
A9D06832	32A	100mA
A9D06840	40A	100mA
A9D06845	45A	100mA

PoN

PoN

PoN

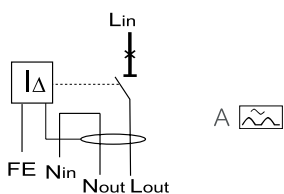

Alternating current (AC) 50/60 Hz		
Breaking capacity (Icn) according to IEC/EN 61009-1		
Current Rating (In)	Voltage (Ue)	(Icn)
6 to 45 A	Ph/N 240 V	10000A
10 to 32 A	Ph/N 110 V	10000A

Acti9 iC60H RCBO 10,30 and 100mA

Acti9 iC60H Residual Current Circuit Breaker with Overload

B Curve

A Type 



A9D31832

B Curve	Rating in amps	Sensitivity rating in milliamps (mA)
A9D31806	6A	30mA
A9D31810	10A	30mA
A9D31816	16A	30mA
A9D31820	20A	30mA
A9D31825	25A	30mA
A9D31832	32A	30mA
A9D31840	40A	30mA
A9D31845	45A	30mA

C Curve

A Type 



A9D11832

C Curve	Rating in amps	Sensitivity rating in milliamps (mA)
A9D10806	6A	10mA
A9D10810	10A	10mA
A9D10816	16A	10mA
A9D10820	20A	10mA
A9D10825	25A	10mA
A9D10832	32A	10mA
A9D10840	40A	10mA
A9D10845	45A	10mA
<hr/>		
A9D11806	6A	30mA
A9D11810	10A	30mA
A9D11816	16A	30mA
A9D11820	20A	30mA
A9D11825	25A	30mA
A9D11832	32A	30mA
A9D11840	40A	30mA
A9D11845	45A	30mA
<hr/>		
A9D12806	6A	100mA
A9D12810	10A	100mA
A9D12816	16A	100mA
A9D12820	20A	100mA
A9D12825	25A	100mA
A9D12832	32A	100mA
A9D12840	40A	100mA
A9D12845	45A	100mA

Acti9 iC60H RCBO 110V (Ph/N) 30mA

Acti9 iC60H Residual Current Circuit Breaker with Overload

C Curve



A9D19832

C Curve	Rating in amps	Sensitivity rating in milliamps (mA)	Rating in volts
A9D19810	10A	30mA	110V
A9D19816	16A	30mA	110V
A9D19820	20A	30mA	110V
A9D19825	25A	30mA	110V
A9D19832	32A	30mA	110V

Alternating current (AC) 50/60 Hz		
Breaking capacity (Icn) according to IEC/EN 61009-1		
Current Rating (In)	Voltage (Ue)	(Icn)
10 to 32 A	Ph/N 110 V	10000A



A9V02663

Vigi iC60 add-on residual current devices						
Type	A Vigi iC60					Width in 9mm modules
Auxiliaries		Without auxiliaries				
1P+N	Sensitivity	30mA	100mA	300mA		
	Rating	25A	-	-	-	3
		63A	A9V02663 A9V01663*	A9V03663	A9V06663	
3P+N	Sensitivity	30mA	100mA	300mA		
	Rating	63A	A9V02763	-	A9V06763	6
Voltage rating (Ue)		230 - 240 V, 400 - 415 V Except * 110 V				
Operating frequency		Except * 110 V				



A9V51225

Vigi iC60 add-on residual current devices									
Type	A Vigi iC60							Width in 9mm modules	
Auxiliaries		Without auxiliaries							
2P	Sensitivity	30mA	100mA	300mA	500mA	300m/s	1000m/s		
	Rating	25A	A9V51225	A9V22225	A9V54225	A9V26225	-	-	3
		63A	A9V51263	A9V22263	A9V54263	A9V26263	A9V25263	A9V29263	4
4P	Sensitivity	30mA	100mA	300mA	500mA	300m/s	1000m/s		
	Rating	25A	A9V51425	A9V22425	A9V54425	A9V26425	-	-	6
		63A	A9V51463	A9V22463	A9V54463	A9V26463	A9V25463	A9V29463	6
Voltage rating (Ue)		230 - 240 V, 400 - 415 V							
Operating frequency		50/60 Hz							



A9V61440

Vigi iC60 add-on residual current devices (SI type)							
Vigi iC60 add-on residual current devices							
Type	SI Vigi iC60						Width in 9mm modules
Auxiliaries		Without auxiliaries					
2P	Sensitivity	10mA	30mA	300m/s	1000m/s		
	Rating	25A	A9V30225	A9V61225	-	-	3
		40A	-	A9V61240	-	-	4
		63A	-	A9V61263	A9V65263	A9V39263	4
4P	Sensitivity	10mA	30mA	300m/s	1000m/s		
	Rating	25A	-	A9V61425	-	-	6
		40A	-	A9V61440	-	-	7
		63A	-	A9V61463	A9V65463	A9V39463	7
Voltage rating (Ue)		230 - 240 V, 400 - 415 V					
Operating frequency		50/60 Hz					

Protection / Circuit protection

Arc fault detection device iARC



BS EN 62606

General requirements for arc fault detection devices.

iARC is an arc fault detection device which aims to reduce the risk of electrical fire. By continuously analysing a large number of electrical parameters, it detects the appearance of electric arcs that are responsible for starting fires. It isolates the circuit concerned, which reduces flame appearance occurrence.

Regulation 421.1.7 of BS 7671: 2018 (IET Wiring Regulations 18th Edition) recommends the use of AFDD to protect against arc fault in AC final circuits. Examples of where AFDDs can be used include:

- premises with sleeping accommodations (e.g., hotels, nursing homes, dwellings)
- locations with a risk of fire due to the nature of processed or stored materials (e.g., barns, wood-working shops, stores of combustible materials)
- locations with combustible constructional materials (e.g., wooden buildings)
- fire propagating structures (e.g. high rise buildings)
- locations where irreplaceable goods are housed (e.g., museums).



iARC must not be installed on circuits requiring a high level of continuity of service.

Regulation 710.421.1.201 of BS 7671: 2018 states that AFDDs are not required to be installed in medical locations of Group 1 and 2, and that in medical locations of Group 0 they shall be used subject to a risk assessment.

iARC is not compatible with ATEX regulations

Catalogue numbers

iARC			
Arc Fault Detection Device (AFDD) to BS EN 62606			Width in 9 mm modules
1P+N			
	Rating 32 A (In)	A9FDD232	4
Operating voltage	230 V AC		
Operating frequency	50 Hz		

Connection

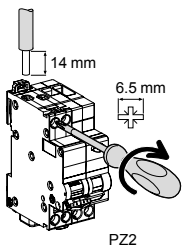

Tightening torque	Copper cables only	
	Rigid	Flexible or with ferrule
2 N.m	1 x 1 to 16 mm ² 2 x 1 to 2.5 mm ²	1 x 1 to 10 mm ² 2 x 1 to 2.5 mm ²

- iARC protects against hazardous electric arc faults that can occur in damaged cables and loose electrical connections that may create intense overheating which could eventually lead to a fire.
- It can provide protection from the following hazardous arc faults that could lead to a fire
- Parallel arc fault: arc fault resulting from damaged insulation between two live conductors or a live conductor and earth in cables or connected equipment that causes a fault current too low to operate protective devices such as fuses or MCBs.
- Series arc fault: arc fault resulting from damaged (crushed or broken) conductor or loose electrical connection in cables or connected equipment in series with a load that causes a fault current too low to operate protective devices such as a fuse or MCB.

It combines the following functions:

- Protection against hazardous arc faults that could lead to a fire
- Circuit opening and positive break indication (green strip)
- Fire hazard tripping indication via the front panel indicator
- Device self-diagnostics via the test button
- Installed in series with a MCB or an RCBO, max 32A, it protects line-to-neutral or line-line circuits, in full coordination under short-circuit conditions up to a rated breaking capacity (Icn) of 10,000 A.

Distribution Board

Incomer

Outgoing Devices

Complimentary Devices

Accessories

Connectivity

Complimentary Devices

Acti9 iID 2P B EV RCCB



Reference	Description	Type	Rating in amps	Sensitivity rating in milliamps (mA)	Width in 9mm modules
A9Z51225	ACT19 IID 2P 25A 30MA B EV RCCB	EV RCCB	25	30	8
A9Z51240	ACT19 IID 2P 40A 30MA B EV RCCB	EV RCCB	40	30	8

Acti9 iID 4P B EV RCCB



Reference	Description	Type	Rating in amps	Sensitivity rating in milliamps (mA)	Width in 9mm modules
A9Z51440	ACT19 IID 4P 40A 30MA B EV RCCB	EV RCCB	40	30	8
A9Z51463	ACT19 IID 4P 63A 30MA B EV RCCB	EV RCCB	63	30	8

Acti9 iID 2P B-SI RCCB



Reference	Description	Type	Rating in amps	Sensitivity rating in milliamps (mA)	Width in 9mm modules
A9Z61225	ACT19 IID 2P 25A 30MA B-SI RCCB	Standard	25	30	8
A9Z61240	ACT19 IID 2P 40A 30MA B-SI RCCB	Standard	40	30	8
A9Z61263	ACT19 IID 2P 63A 30MA B-SI RCCB	Standard	63	30	8
A9Z64225	ACT19 IID 2P 25A 300MA B-SI RCCB	Standard	25	300	8
A9Z64240	ACT19 IID 2P 40A 300MA B-SI RCCB	Standard	40	300	8
A9Z64263	ACT19 IID 2P 63A 300MA B-SI RCCB	Standard	63	300	8

Acti9 iID 4P B-SI RCCB



Reference	Description	Type	Rating in amps	Sensitivity rating in milliamps (mA)	Width in 9mm modules
A9Z61425	ACT19 IID 4P 25A 30MA B-SI RCCB	Standard	25	30	8
A9Z61440	ACT19 IID 4P 40A 30MA B-SI RCCB	Standard	40	30	8
A9Z61463	ACT19 IID 4P 63A 30MA B-SI RCCB	Standard	63	30	8
A9Z61480	ACT19 IID 4P 80A 30MA B-SI RCCB	Standard	80	30	8
A9Z64425	ACT19 IID 4P 25A 300MA B-SI RCCB	Standard	25	300	8
A9Z64440	ACT19 IID 4P 40A 300MA B-SI RCCB	Standard	40	300	8
A9Z64463	ACT19 IID 4P 63A 300MA B-SI RCCB	Standard	63	300	8
A9Z64480	ACT19 IID 4P 80A 300MA B-SI RCCB	Standard	80	300	8
A9Z65440	ACT19 IID 4P 40A 300SMA B-SI RCCB	Standard	40	300	8
A9Z65463	ACT19 IID 4P 63A 300SMA B-SI RCCB	Standard	63	300	8
A9Z65480	ACT19 IID 4P 80A 300SMA B-SI RCCB	Standard	80	300	8
A9Z66440	ACT19 IID 4P 40A 500MA B-SI RCCB	Standard	40	500	8
A9Z66463	ACT19 IID 4P 63A 500MA B-SI RCCB	Standard	63	500	8
A9Z66480	ACT19 IID 4P 80A 500MA B-SI RCCB	Standard	80	500	8

iCT 3P+N Contactor



Provides an optimized solution with desynchronized and reinforced contacts for head of group lighting applications.

Reference	Description	Ratings (In)	
		AC7a	AC7b
A9C24740	A9 iCT 40A 3PN 4NO 230/240VAC50HZ	40A	15A
A9C22740	A9 iCT 40A 3PN 4NC 230/240VAC50HZ	40A	15A
A9C24763	A9 iCT 63A 3PN 4NO 230/240VAC50HZ	63A	20A
A9C22763	A9 iCT 63A 3PN 4NC 230/240VAC50HZ	63A	20A



Timers, Time and Twilight switches

Time Switches - Digital



CCT15441

Part Number	Description
CCT15441	IHP 1C w (45mm)
CCT15443	IHP 2C w (45mm)
CCT15551	IHP+ 1C SMARTw (45mm)
CCT15553	IHP+ 2C SMARTw (45mm)
CCT15854	IHP 1C 18mm Digital Timer
CCT15838	IHP+ 1C 18mm Digital Timer
CCT15910	ITA 1C 36mm Digital Timer Yearly
CCT15940	ITA 4C 72mm Digital Timer Yearly

Time Switches - Mechanical



15337

Part Number	Description
CCT15338	IH 60m 1C 54mm Mech Timer
CCT16364	IH 24h 1C 54mm Mech Timer
CCT15365	IH 24h 1C Res 54mm Mech Timer
15337	IH 24h 2C Res 54mm Mech Timer
15366	IH 24h7d 1+1C Res 54mm Mech Timer
CCT15367	IH 7d 1C Res 54mm Mech Timer
15335	IH 24h 1C 18mm Mech Timer
15336	IH 24h 1C Res 18mm Mech Timer
15331	IH 7d 1C Res 18mm Mech Timer

Timers



CCT15232

Part Number	Description
15363	MIN time switch 1-7mins (delayed off)
CCT15232	MINs timer 0.5 - 20min
CCT15233	MINp delay off timer 50% warning
CCT15234	MINt off warning, impulse relay
15359	MIN timer terminal shield

Distribution Board

Incomer

Outgoing Devices

Complimentary Devices

Accessories

Connectivity

Twilight Switches



CCT15494

Part Number	Description
CCT15494	IC100kp+ 1C SMART
CCT15495	IC100kp+ 2C SMART
CCT15225	IC Astro 1C SMART
CCT15245	IC Astro 2C SMART
CCT15482	IC100
CCT15285	IC2000d indoor (18mm)
CCT15369	IC2000d outdoor (18mm)
CCT15483	IC2000p+

Accessories



CCT15260

Part Number	Description
CCT15262	Indoor analogue light sensor cell
CCT15263	O/door analogue light sensor cell
CCT15260	Digital add-on sensor (external)
CCT15261	Digital build-in sensor (switch board)
CCT15860	IHP+ key programming tool - PC
CCT15861	IHP+ programming key
CCT15950	ITA programming tool
CCT15955	ITA programming key
CCT15970	ITA GPS Antenna

Acti9 Isobar P three phase accessories

General accessories



SEA9250SPEV



SEA9BL



SEA9BP



SEA9ISOPLA



SEA9BP3

Part Reference	Description
SEA9P125SPKIT	125A Single phasing kit 4 pole*
SEA9250SPEV	250A Single phasing kit 4 pole
SEA9BL	Door Lock
SEA9PD	Padlock Kit for Door
SEA9LA	Pack of 3 padlock attachment MCB
SELACK	15mm padlock common key
SELADK	15mm padlock different key
SEA9BP	Blank Pole
SEA9BP3	Single 3 Pole filler
SEA9TB1001	100amp 1 pole terminal block
SEA9BNWL	TP&N Labels
SEA9NEK1	Extra earth terminal bar 14 hole
SEA9NEK2	Extra earth terminal bar 20 hole
SEA9NEK3	Extra earth terminal bar 26 hole
SEA9BN63SPL	Split Load kit 63amp
SEA9BNSJKN	Side joining kit
SEA9BNTJKB	Top / Bottom kit replacing Gland Plate
SEA9BNTJKA	Top / Bottom joining kit for Enclosure / Extension Enclosure
SEA9BNTJKN	Joining Kit B Board Top / Bottom
SEA9BNBCE25	Clean Earth B Board 25 Holes
SEA9BNC	Neutral Shroud (Spare)
SEA9ISOKEY	Pack of 5 Isobar Disconnecter switch Keys
SEA9BGPEXN	Gland Plate for Acti9 Isobar 4 Extension
SEA9FCF	Pack of 24 Fixing Screws
SEA9BNGPN	Isobar B board top/bottom gland
SEA9BNGPNKO	Isobar B board top/bottom gland with knockouts
SEA9ISOPLA	Slider padlock attachment
SEK33	Spare keys

* SEA9125SPEV is not compatible with SEA9BP** PoN distribution boards. To correctly single phase SEA9BP** PoN distribution boards **SEA9P125SPKIT** must be used.



SEA8BNSJKN



SEA9BNTJKB



SEA9BNTJKA



SEA9BNTJKN

Distribution Board

Incomer

Outgoing Devices

Complimentary Devices

Accessories

Connectivity

Distributed neutral kits



SEA9NA27

Part reference	Description	No of Ways
SEA9NA6	Distributed neutral kit for 6way SP&N	6
SEA9NA10	Distributed neutral kit for 10way SP&N	10
SEA9NA14	Distributed neutral kit for 14way SP&N	14
SEA9NA18	Distributed neutral kit for 18way SP&N	18
SEA9NA27	Distributed neutral kit for 27way SP&N	27
SEA9NKIT	Phase to Neutral conversion kit (pack of 4, distributed neutral kit also required)	

- This kit allows you to distribute and control the neutral through the board for 4 outgoing circuits.

Top or bottom extension enclosures (height 270 mm)

For use with Acti9 Isobar P B Type distribution boards, used for additional wiring space or to house din rail mounted equipment



SEA9BNEX034N

Part Reference	Description
SEA9BNEXN	Plain front cover for additional wiring space
SEA9BNEX034N	Mounting of DIN devices, overall door and cutout for 17x18mm poles
SEA9BNEXA14N	Single phase add on distribution Board 14 ways

Side extension enclosures



SEA9BN4SXS

Part reference	Description	No of Rows	Total 18mm SP Ways	Same Dimensions as:
SEA9BN4SXS	Slotted Front Cover & Overall Door	2	34	SEA9BPN4
SEA9BN8SXS	Slotted Front Cover & Overall Door	2	34	SEA9BPN8
SEA9BN12SXS	Slotted Front Cover & Overall Door	3	51	SEA9BPN12
SEA9BN16SXS	Slotted Front Cover & Overall Door	4	68	SEA9BPN16
SEA9BN24SXS	Slotted Front Cover & Overall Door	5	85	SEA9BPN24
SEA9BN4SXP	Plain Front Cover & Overall Door	2	34	SEA9BPN4
SEA9BN8SXP	Plain Front Cover & Overall Door	2	34	SEA9BPN8
SEA9BN12SXP	Plain Front Cover & Overall Door	3	51	SEA9BPN12
SEA9BN16SXP	Plain Front Cover & Overall Door	4	68	SEA9BPN16
SEA9BN24SXP	Plain Front Cover & Overall Door	5	85	SEA9BPN24



Acti9 Isobar P and AFDD Arrangements

Extension Enclosures can provide additional DIN rail ways to accommodate devices such as Contactors, SPD and AFDD.

Distribution Boards

Acti9 Isobar three phase B type distribution board



Part reference	No of Triple Pole Ways
SEA9BPN4	4
SEA9BPN6	6
SEA9BPN8	8
SEA9BPN12	12
SEA9BPN16	16
SEA9BPN18	18
SEA9BPN24	24

Acti9 Extension Enclosure

Top or Bottom extension enclosures (Height 270 mm)



Part reference	Description	No of Rows	Total 18mm SP Ways	No of AFDD (A9FDD232)
SEA9BNEX034N	Mounting of DIN devices, overall door and cutout for 17x18mm poles	1	17	8

or Side extension enclosures



Part reference	Description	No of Rows	Total 18mm SP Ways	Same Dimensions as:	No of AFDD (A9FDD232)
SEA9BN4SXS	Slotted Front Cover & Overall Door	2	34	SEA9BPN4	16
SEA9BN8SXS	Slotted Front Cover & Overall Door	2	34	SEA9BPN8	16
SEA9BN12SXS	Slotted Front Cover & Overall Door	3	51	SEA9BPN12	24
SEA9BN16SXS	Slotted Front Cover & Overall Door	4	68	SEA9BPN16	32
SEA9BN24SXS	Slotted Front Cover & Overall Door	5	85	SEA9BPN24	40
SEA9BN4SXP	Plain Front Cover & Overall Door	2	34	SEA9BPN4	16
SEA9BN8SXP	Plain Front Cover & Overall Door	2	34	SEA9BPN8	16
SEA9BN12SXP	Plain Front Cover & Overall Door	3	51	SEA9BPN12	24
SEA9BN16SXP	Plain Front Cover & Overall Door	4	68	SEA9BPN16	32
SEA9BN24SXP	Plain Front Cover & Overall Door	5	85	SEA9BPN24	40

Acti9 DB + Extension Enclosure

Distribution Board

Incomer

Outgoing Devices

Complimentary Devices

Accessories

Connectivity

Acti 9 Isobar P connected products

Connect your Acti9 Isobar P distribution board using wireless connectivity to see the power and optimise the use of your assets with Facility Expert our simple on-line services platform

Acti9 iC60 RCBO PowerTag wireless sensors

Rated at 63A it assembles on to Acti9 iC60 RCBOs optimising asset management through real time monitoring and alarming of V, I, P, PF and loss of voltage



A9MEM1563

Part Reference	Type	Type of mounting
A9MEM1563	1PN	Bottom of RCBO

Acti9 iC60 PowerTag wireless sensors

Rated at 63A it assembles on to Acti9 iC60 mcbcs optimising asset management through real time monitoring and alarming of V, I, PF, kWh and loss of voltage



A9MEM1520

Part Reference	Type	Type of mounting
A9MEM1520	Acti9 PowerTag 1PN	Top or bottom of mcb
A9MEM1521	Acti9 PowerTag 1P+N	Top of mcb
A9MEM1522	Acti9 PowerTag 1P+N	Bottom of mcb
A9MEM1540	Acti9 PowerTag 3P Max 63A	Top or bottom of mcb
A9MEM1541	Acti9 PowerTag 3P+N	Top of mcb
A9MEM1542	Acti9 PowerTag 3P+N	Bottom of mcb

Acti9 Isobar P Ready to Install PowerTag extension kit

Compatible with all three phase distribution boards it contains an SiD Din Smartlink wireless concentrator, power and neutral reference terminals and Ethernet connection. It has wireless connectivity for up to 100 PowerTag wireless energy sensors



A9PTGEXTNP

Part Reference	Description
A9PTGEXTNP	Wireless connectivity for up to 20 PowerTag
A9PTGEXTNPHD	Wireless connectivity for up to 100 PowerTag

Acti9 Isobar P Ready to install PowerTag retrofit side extension kit

Capable of retrofit adaptation to all Acti9 Isobar three phase distribution boards it contains an SiD Din Smartlink wireless concentrator, power and neutral reference terminals and ethernet connection. It has wireless connectivity for up to 20 PowerTag wireless energy sensors



A9PTGRK

Part Reference	Description
A9PTGRK	Wireless connectivity for up to 20 PowerTag

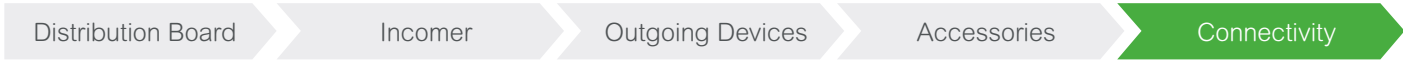

Acti 9 Isobar P connected products

Acti9 Isobar P three phase distribution board PowerTag for incomers

Rated at 250A or 630A the Compact NSX PowerTag wireless energy sensor assembles on to the bottom of a 3P or 4P MCCB (100A to 250A) or switch disconnector (160A to 250A) optimising asset management through monitoring and alarming of V, I, P, PF and loss of voltage



LV434021

Part Reference	Description
LV434020	250A NSX MCCB PowerTag 3P
LV434021	250A NSX MCCB PowerTag 3P+N

Acti9 Isobar P distribution board SiD Din Smartlink

Compatible with all distribution boards, the SiD Din Smartlink wireless concentrator has wireless connectivity for up to 100 PowerTag wireless energy sensors



A9XMWA20

Part Reference	Description
A9XMWD20	PowerTag Link RF to IP gateway
A9XMWD100	PowerTag Link HD RF to IP gateway

Acti9 PowerTag digital I/O modules

These wireless input/output modules allow circuit control and status monitoring. Designed for use in commercial and building applications, they quickly and easily turn your distribution board into a connected panel.



A9XMC1D3

Part Reference	Description
A9XMC1D3	PowerTag C IO 230V
A9XMC2D3	PowerTag 2DI 230V

LoadCenter KQ

Contents

■ Introduction

KQ Overview	Pg 53
LoadCenter KQ distribution board features	Pg 54

■ LoadCenter KQ

LoadCenter KQ - single phase A type distribution boards - 125A	Pg 54
LoadCenter KQ - three phase B type distribution boards - 250A	Pg 57
LoadCenter KQ - iKQ Miniature Circuit Breakers (MCB's)	Pg 61
LoadCenter KQ - Residual Current Circuit Breakers (RCBO's)	Pg 63
LoadCenter KQ - Residual Current Circuit Breakers (RCCB's)	Pg 64
LoadCenter KQ - extension enclosures	Pg 65

LoadCenter KQ overview

Plug-on Circuit Protection unique to Schneider Electric

- Plug-On breaker connections are designed so that under short circuit conditions, the magnetic forces developed push the jaws together, gripping the busbar more firmly
- No wiring connections need to be made to the busbars as the connectors form an integral part of the circuit breakers
- All MCB's* plug onto the busbar stack



LoadCenter KQ

Distribution boards

- **Plug-On devices help reduce installation time**
- **Simple to add** or retrospectively change outgoing devices
- **Boards are supplied complete and ready to install.** Simply mount to the wall and fit the required MCBs. The board is then ready for cabling
- Plug-on devices ensure **consistent connections**
- **Quality** - busbar systems are certified and the unique mounting system ensures devices cannot be incorrectly fitted
- **Proven experience** - The KQ distribution boards have been used extensively across commercial applications.

LoadCenter KQ distribution boards

Circuit protection

Features:

- Plug on technology
- Enhanced incoming section
- Shrouded neutral terminal bar
- Modular enclosure sizes
- IP2XB encapsulated busbar
- Control devices
- Removable gland plates
- Split earth & neutral bars
- 25mm cables accepted
- Integral cable way
- Increased enclosure size



Benefits:

- 50% fewer connections, reliable connections
- Time saving on installation
- Additional safety feature
- Join together top/bottom or side/side
- Safety feature – throughout offer
- Can be fitted in any spare outgoing ways
- Ease of installation (plain / knockouts)
- Easier installation and cable zoning
- Earth & neutral termination points
- Easier wiring on control devices
- More wiring space

KQ features

- **Fully retrofittable**
Devices will fit older KQ boards without modification
- **Class 2 front face**
Double insulated front cover – IP40
- **VisiTrip**
Visible indication of tripped position
- **VisiSafe**
Withstand of 6kV impulse
Green indication strip – contacts separated by required distance
- **Breaking capacity**
Domestic or similar / BS EN 60898 / 10kA
- **Shuttered terminals**
IP 20 finger safe terminals with insulated shutters on all KQ devices



LoadCenter KQ - single phase A type distribution boards - 125A

- Manufactured and tested to BS EN 61439-3
- Maximum busbar rating 125A
- Voltage rating 230/240V AC
- External IP3X protection to BS EN 60529
- Internal IP2XB protection to BS EN 60529 provided by permanent, non removable, factory fitted barriers
- Shielded neutral bars
- Cable knockouts on all sides for speed of installation
- Earth bar capacity 25mm²
- Neutral bar capacity 25mm²
- Wide range of bolt-on incomers, Plug-On outgoers
- All A boards accept DIN control products e.g. contactors, time clocks, in any unused outgoing way without adaptation

Standard type (excluding incomers)



SE125A12

Reference number	Number of SP ways
SE125A6	6
SE125A8	8
SE125A12	12
SE125A16	16
SE125A24	24

Split meter board (including incomers)



SEA14S14

Reference number	Number of ways	
	Lighting	Power
SEA10S10 *	10	10
SEA14S14 *	14	14

The split metering board is supplied with 2 x 63A A9MEM2105 meters, an overall switch disconnect and individual 50A 2P Miniature Circuit Breakers for lighting and power. Meters are direct connected with pulse output.

*Max Load per row 50A.

Type A LoadCenter KQ+ DIN incoming devices



SE125SW2



SED63032

Reference number	Device type	Current rating	Number of poles	Standard approval	Cable capacity mm ²
SE125L2	Terminal block	125A	2	–	50
SE125SW2	Switch disconnecter	125A	2	BS EN 60947-3	50
SED63032	RCCB	63A, 30mA	2	BS EN 61008	35
SED63102	RCCB	63A, 100mA	2	BS EN 61008	35
SED63302	RCCB	63A, 300mA	2	BS EN 61008	35
SED100032	RCCB	100A, 30mA	2	BS EN 61008	50
SED100102	RCCB	100A, 100mA	2	BS EN 61008	50

125A A board accessories



SEAE16



SE1100L

Reference number	Device type
SEK	Barrel lock and 2 keys new square door catch
SEDNBP3	Blanking plate (3 poles)
SEPLMCB	MCB padlock attachment (pk 3)
SEPLRCBO	RCBO padlock attachment (pk 10)
SEPL	Padlock
SEAE16	16 SP way DIN module enclosure (W489 x H300 x D117mm) includes Earth bar.
SE1100L	100A lug unit single pole
SESDC	Replacement door catch
SEDN25BP3	Blanking plate 25 x 3

LoadCenter KQ - three phase B type distribution boards - 250A

- Manufactured and tested to BS EN 61439-3
- Maximum busbar rating 250A
- Voltage Rating 400/415V AC
- External IP3X protection to BS EN 60529
- IP2XB finger safe with door and cover removed to BS EN 60529, provided by permanent, non removable, factory fitted barriers
- Fully shielded neutral bars
- Earth and neutral bar cable capacity 25mm² M8 earth bar stud
- All incoming connections are the same length i.e. 4 pole configuration
- Range of integral incomers for all applications including lugs, switches, RCCB's and MCCB's
- Outgoing MCB's available up to 63A B, C or D curves
- 18mm wide RCBO.
- Plug-On outgoing for speed of installation and reliable connections
- All B boards accept DIN control products (timers, contactors) in any unused outgoing way without adaptation
- Control wiring cable way integrated to moulding

Standard type (excluding incomers)



SE18B250

Reference number	Number of TP ways
SE12B250	4
SE18B250	6
SE24B250	8
SE36B250	12
SE48B250	16
SE54B250	18
SE72B250	24

Split load (excluding incomers)



SE18B250
+
SEJK
+
SE18B250

Reference number	Number of TP ways		Reference number	Number of TP ways
SE12B250	4	} + }	SE12B250	4
SE18B250	6		SE18B250	6
SE24B250	8		SE24B250	8
SE36B250	12		SE36B250	12
SE48B250	16		SE48B250	16
SE54B250	18		SE54B250	18
SE72B250	24		SE72B250	24

Split load joining kit for mechanical connection SEJK.

63A tapoff to feed protected board (including joining kit) SE63SLK.

Extra service units 125A (combination of a standard board and DIN rail enclosure)



SE12B2D

Reference number	Number of TP busbar ways		Reference number	Number of rows	Number of modules
SE12B250	4	}	SE17BES	1	17
SE18B250	6		SE12B2D	2	34
SE24B250	8		SE18B2D	2	34
SE36B250	12		SE36B3D	3	51
SE48B250	16		SE54B4D	4	68
SE54B250	18				
SE72B250	24				

Extra service units are designed for application using numerous control products and RCCB's.

These units provide a professional finish while economising on ease and speed of installation.

Split metering board 125A



SEB36S24125

Reference number	Number of TP ways		Rating A
	Section 1	Section 2	
SEB36S24125	14	8	125
SEB42S18125	16	6	125
SEB48S12125	18	4	125

2 x A9MEM3255 MID approved meters with pulsed and modbus outputs.

Factory fitted incoming 3P+N switch disconnecter.

Split metering board 250A



SEB36S24250

Reference number	Number of TP ways		Rating A
	Section 1	Section 2	
SEB36S24250	14	8	250
SEB42S18250	16	6	250
SEB48S12250	18	4	250

250A boards require a switch disconnecter to be added (page 55)

2 x A9MEM3255 MID approved meters with pulsed and modbus outputs.

Incomers for 250A split metered boards



Reference number	Device type	Current rating	Number of poles	Standard approval	Cable capacity mm ²
SE160SW4SM	Switch disconnecter	160A	4	BS EN 60947-3	95
SE200SW4SM	Switch disconnecter	200A	4	BS EN 60947-3	185
SE250SW4SM	Switch disconnecter	250A	4	BS EN 60947-3	185
SE160MCCB3LSM	MCCB	160A	4	BS EN 60947-2	95
SE200MCCB3LSM	MCCB	200A	4	BS EN 60947-2	185
SE250MCCB3LSM	MCCB	250A	4	BS EN 60947-2	185

125A type B LoadCenter KQ incoming devices



SE125SW4

Reference number	Device type	Current rating	Number of poles	Standard approval	Cable capacity mm ²
SE125L4	Terminal block	125A	4	–	50
SE125SW4	Switch disconnecter	125A	4	BS EN 60947-3	50
SE125SW3L	Switch disconnecter	125A	3+N lug	BS EN 60947-3	50
SED80034	RCCB	80A, 30mA	4	BS EN 61008	35
SED100304	RCCB	100A, 300mA	4	BS EN 61008	50
SED100304S	RCCB	100A, 300mA TD	4	BS EN 61008	50
SECSW100	Contactora + switch	100A	4	BS EN 60439	50

250A type B LoadCenter KQ incoming devices



SE250SW3L



SE160RCD

Reference number	Device type	Current rating	Number of poles	Standard approval	Cable capacity mm ²
SE250L4P	Terminal block	250A	4	–	185
SE160SW3L	Switch disconnecter	160A	3+N	BS EN 60947-3	95
SE200SW3L	Switch disconnecter	200A	3+N	BS EN 60947-3	185
SE250SW3L	Switch disconnecter	250A	3+N	BS EN 60947-3	185
SE160SW4	Switch disconnecter	160A	4	BS EN 60947-3	95
SE200SW4	Switch disconnecter	200A	4	BS EN 60947-3	185
SE250SW4	Switch disconnecter	250A	4	BS EN 60947-3	185
SE100MCCB3L	MCCB	100A	3+N	BS EN 60947-2	95
SE160MCCB3L	MCCB	160A	3+N	BS EN 60947-2	95
SE200MCCB3L	MCCB	200A	3+N	BS EN 60947-2	185
SE250MCCB3L	MCCB	250A	3+N	BS EN 60947-2	185
SE160RCD	RCCB 160A	Adjustable 30mA - 10A	4	BS EN 61008	95

Note Supplied with 400mm extension box

Metering extension kit



SE250MET

Reference number	Description
SE250MET	MID 3 Phase kWh kit modbus communications and pulsed output (Includes A9MEM3255)

B board accessories



SEPLMCB



SEPLRCBO



SEBES

Reference number	Device type
SESJK	Side joining kit
SEJK	Top/bottom joining kit
SE63SLK	63A Top off or split load
SEK	Barrel lock and 2 keys for catch
SEK33	Spare keys
SE125SPP	125A single phasing kit for use with RCD and switch incomers
SE250SPP	250A single phasing kit
SEDNBP3	Blanking plate (3 poles)
SEPLMCB	MCB padlock attachment (pk 3)
SEPLRCBO	RCBO padlock attachment (pk 10)
SEPL	Padlock
WALLET	Circuit directory and wallet (pack of 10)
SEPD	Padlocking door kit
SEBES	Plain extension box (Height 270mm)
SE1100L	100A lug unit single pole
SEGP	Spare gland plate with knockouts (12 x 20mm and 1 x 40mm)
SEGP	Spare gland plate - Plain
SECE12T	Clean earth 12 terminals
SE72BL	Spare way label 72 ways
SEEXGP	Spare gland plate for extension box
SESDC	Spare door catch
SEBNC	Neutral terminal cover
SEBFCF	Spare cover fixing (24)
SECBK	Cross brace kit for SEBES
SELA	MCB padlock attachment (bag of 3)
SEDN25BP3	Blanking plate 25 x 3



SESJK



SEJK

LoadCenter KQ - iKQ Miniature Circuit Breakers (MCB's)

- Manufactured and tested to BS EN 60898
- 10kA breaking capacity
- Let through energy classification of 3 (lowest let through energy giving best cable protection classification)
- Positive contact indication (guaranteed on/off indication)
- Trip free mechanism operates even when the toggle is locked on
- Lockable in the ON or OFF position
- Speed of connection of Plug-On devices - Reliable connection
- For use in LoadCenter KQ A and B boards

Type B (magnetic setting 3-5 in)

For resistive and light reactive loads, e.g. heating, incandescent lighting etc



SE10B132

Reference numbers			Current rating (Icn*)	Cable capacity mm ²
1 pole	2 pole	3 pole		
SE10B106	-	-	6A	25
SE10B110	-	-	10A	25
SE10B116	-	-	16A	25
SE10B120	-	-	20A	25
SE10B132	-	-	32A	35
SE10B140	-	-	40A	35
SE10B150	-	-	50A	35
SE10B163	-	-	63A	35

Type C (magnetic setting 5-10 in)

For moderately light reactive loads, e.g. fluorescent lighting



SE10C332

Reference numbers			Current rating (Icn*)	Cable capacity mm ²
1 pole	2 pole	3 pole		
SE10C106	-	SE10C306	6A	25
SE10C110	-	SE10C310	10A	25
SE10C116	-	SE10C316	16A	25
SE10C120	-	SE10C320	20A	25
SE10C125	-	SE10C325	25A	25
SE10C132	-	SE10C332	32A	35
SE10C140	-	SE10C340	40A	35
SE10C150	-	SE10C350	50A	35
SE10C163	-	SE10C363	63A	35

Type D (magnetic setting 10-14 in)

For highly reactive loads, e.g. motors, pumps and transformers



SE10D332

1 pole	Reference numbers		Current rating (Icn*)	Cable capacity mm ²
	2 pole	3 pole		
-	-	SE10D306	6A	25
-	-	SE10D316	16A	25
-	-	SE10D320	20A	25
-	-	SE10D325	25A	25
-	-	SE10D332	32A	35
-	-	SE10D340	40A	35
-	-	SE10D350	50A	35
-	-	SE10D363	63A	35

DIN rail mounted 80/100A MCB

Suitable for use in extension enclosures or extra service units



KQ10C3100

Reference number	Description	Terminal capacity	Modular size
KQ10C3100	MCB 3P 100A Type C	50	4.5
KQ10C380	MCB 3P 80A Type C	50	4.5

Must be used with SE17BES enclosure and 3 x SE1100L.

LoadCenter iKQ - Residual Current Circuit Breakers with Overload (RCBO's)

- Manufactured and tested to BS EN 61009
- 10kA breaking capacity
- Let through energy classification of 3 (lowest let through energy giving best cable protection classification)
- Positive contact indication on toggle (guaranteed on/off indication)
- Trip free MCB mechanism
- Lockable in the ON or OFF position
- Automatic trip on loss of neutral
- Automatic protection against reverse polarity
- Type B and C characteristics
- Operating voltage 150 - 230Vac
- 6 - 45A; 30mA sensitivities
- A class sensitivity
- For use in KQ LoadCenter A and B boards
- One single pole way occupied in a distribution board ideal for retrofitting earth fault protection
- Cable capacity 16mm²
- Speed of connection of Plug-On devices
- Assured system integrity, no other devices fit KQ boards

Applications

RCBO's are available with 30mA earth leakage sensitivities to suit applications including personnel protection.

RCBO's should be carefully selected for the relevant application.

Residual Current Circuit Breakers - A type



SEE132C03

Reference number	Current rating	Tripping curve	Sensitivity	Cable capacity mm ²
SEE106B03	6A	B	30mA	16
SEE110B03	10A	B	30mA	16
SEE116B03	16A	B	30mA	16
SEE120B03	20A	B	30mA	16
SEE125B03	25A	B	30mA	16
SEE132B03	32A	B	30mA	16
SEE140B03	40A	B	30mA	16
SEE145B03	45A	B	30mA	16
SEE106C03	6A	C	30mA	16
SEE110C03	10A	C	30mA	16
SEE116C03	16A	C	30mA	16
SEE120C03	20A	C	30mA	16
SEE125C03	25A	C	30mA	16
SEE132C03	32A	C	30mA	16
SEE140C03	40A	C	30mA	16
SEE145C03	45A	C	30mA	16

LoadCenter KQ - Residual Current Circuit Breakers (RCCB's)

All Residual Current Circuit Breakers are suitable for use as main incomers in LoadCenter KQ distribution boards.

- Comply with BS EN 61008. Specification for Residual Current operated Circuit Breakers
- Rated voltage 240/415V AC 50/60 Hz
- Test button enables RCCB to be tested periodically

- 30mA device suitable for use as additional protection on final sub circuits
e.g. equipment outside equipotential zone or items requiring 2/4 pole protection
i.e. switched neutral applications

Residual Current Circuit Breakers - AC type



SED40032



SED40034

Reference number	Description	Cable capacity mm ²
SED40032	40A RCCB 30mA trip 2 pole	35
SED40102	40A RCCB 100mA trip 2 pole	35
SED63032	63A RCCB 30mA trip 2 pole	35
SED63102	63A RCCB 100mA trip 2 pole	35
SED63302	63A RCCB 300mA trip 2 pole	35
SED80032	80A RCCB 30mA trip 2 pole	50
SED100032	100A RCCB 30mA trip 2 pole	50
SED100102	100A RCCB 100mA trip 2 pole	50
SED25034	25A RCCB 30mA trip 4 pole	35
SED25104	25A RCCB 100mA trip 4 pole	35
SED25304	25A RCCB 300mA trip 4 pole	35
SED40034	40A RCCB 30mA trip 4 pole	35
SED40104	40A RCCB 100mA trip 4 pole	35
SED40304	40A RCCB 300mA trip 4 pole	35
SED63034	63A RCCB 30mA trip 4 pole	35
SED63104	63A RCCB 100mA trip 4 pole	35
SED63304	63A RCCB 300mA trip 4 pole	35
SED80034	80A RCCB 30mA trip 4 pole	35
SED100304	100A RCCB 300mA trip 4 pole	50
SED100304S	100A RCCB 300mA trip 4 pole + TD	50

LoadCenter KQ - extension enclosures

LoadCenter KQ enclosures are available for applications where matching extension boxes are required to house system extensions or stand alone control systems.

There are two configurations, plain enclosures with door, enclosures with DIN rail, door and front cover assembly.

Steel enclosures with plain cover and door



Reference number	Description
SE12BCD	450mm with cover and door
SE18BCD	540mm with cover and door
SE36BCD	675mm with cover and door
SE54BCD	819mm with cover and door

SEJK - Joining Kit (If connected to board)

Steel enclosures with DIN rails and a front cover assembly and door



Reference number	Number of rows	Total number of SP modules
SE12B2D	2	34
SE18B2D	2	34
SE36B3D	3	51
SE54B4D	4	68

Steel enclosure with 1 row of DIN rails and a front cover assembly and door



SE17BES

Reference number	Number of rows	Total number of SP modules
SE17BES	1	17

Steel enclosure



SEBES

Reference number	Number of rows	Total number of SP modules
SEBES	-	-

Control devices and accessories



A9C20732

Reference	Description
A9C20732	iCT 25A 2NO 230...240VAC 50HZ Contactor
A9C20834	iCT 25A 4NO 220...240VAC 50HZ Contactor
A9C20842	iCT 40A 2NO 220...240VAC 50HZ Contactor
A9C20843	iCT 40A 3NO 220...240VAC 50HZ Contactor
A9C20844	iCT 40A 4NO 220...240VAC 50HZ Contactor
A9C20863	iCT 63A 3NO 220...240VAC 50HZ Contactor
A9C30811	iTL16A 1NO 230/240VAC 50-60HZ 110V
A9C30812	iTL16A 2NO 230/240VAC 50-60HZ 110V
A9E15535	Changeover relay iRL1 10A 2P UC 230V-240
A9A15321	ISO bell 8 12V
A9A15214	Bell transformer 4VA 230VCA 8VCA
A9A15323	Buzzer 8..12 VCA 70DBA 50..60HZ
A9C20884	iCT 100A 4NO 220...240VAC 50HZ Contactor

Surge Protection for installation with KQ boards, supplied with external insulated enclosure connections and iKQ MCB



CF1PN40

Reference	Description	Supplying MCB (to be installed in the distribution board)
CF1PN40	Type 2 Surge Arrester 40kA 1P+N	SE10C140
CF1PN8	Type 2/3 Surge Arrester 8kA 1P+N	SE10C110
CF3PN40	Type 2 Surge Arrester 40kA 3P+N	SE10C340
CF3PN8	Type 2/3 Surge Arrester 8kA 3P+N	SE10C310

Surge Protection DIN rail mounted



A9L16634

Reference	Description
A9L16282	iPRD1 12,5R 1P+N Type 1/2 combined
A9L40500	iPRD 40 40 KA 340V 1P+N Type 2
A9L80500	iPRD 8 8 KA 230V 1P&N Type 2/3
A9L16482	iPRD1 12,5R 3P+N Type 1/2 combined
A9L40600	iPRD 40 40 KA 340V 3P+N Type 2
A9L08601	iPRD 8 8 KA 340V 3P+N Type 2/3

* requires upstream MCB for protection





Easy9

Contents

■ Introduction

Easy9 overview	Pg 71
9 Reasons to choose Easy9	Pg 72
Affordable circuit protection you can depend on	Pg 74

■ Easy9

Devices	Pg 76
Semi-flush mount frame	Pg 77
Product selector	Pg 78
Select consumer units with switch/RCD's fitted	Pg 79
Devices	Pg 80



Easy9 overview

Catered to your needs

Easy9 offers a conventional busbar system.

Enclosure: can be modified to suit split and configuration on site

Flexible split load configuration option: ensures mainstream applications can be catered for with a single consumer unit

Rigid metal DIN rail: solid to avoid flexing and raised for cabling flexibility

Secure busbar guard: requires tool for removal, ensuring more safety for you

MCB style blanking module: additional end user safety feature, requiring enclosure cover to be removed first





Easy9

9 Reasons to choose Easy9

#1

Contemporary design

Crisp white modern design

Stylish finish for any residential environment.

#2

Green Premium product

Sustainable performance, by design

The Green Premium programme stands for our commitment to deliver customer-valued sustainable performance.

#3

Easy to read label kits

Visual aids

Instantly understand control points throughout the home.

#4

BS7671 compliant

Full metal enclosure

Prevents any flex or distortion when mounting the unit to any surface.

#5

Fast & easy to install

Easier to install

Improved design to offer cabling space where it is needed most.

#6

Numbered terminals

Ensures correct insertion and termination

Consistent and clear numbering with conductor clearance.

#7

Rigid DIN rail

Safe and strong

The DIN rail provides a solid feel whilst the busbar guard provides peace of mind.

#8

Recessed design

Minimise impact

Flexible enclosure, for a less intrusive look within your living space.

#9

Reversible enclosure door

Simply no downsides

Need the door to open up or down? Central fixing points make this a simple change. Lending itself to modern interiors.

Easy9

Affordable circuit protection you can depend on

Schneider Electric warranty

Comprehensive range

Full compliance with international IEC standards
3rd party certification

Installer-friendly wiring with only 1 screwdriver



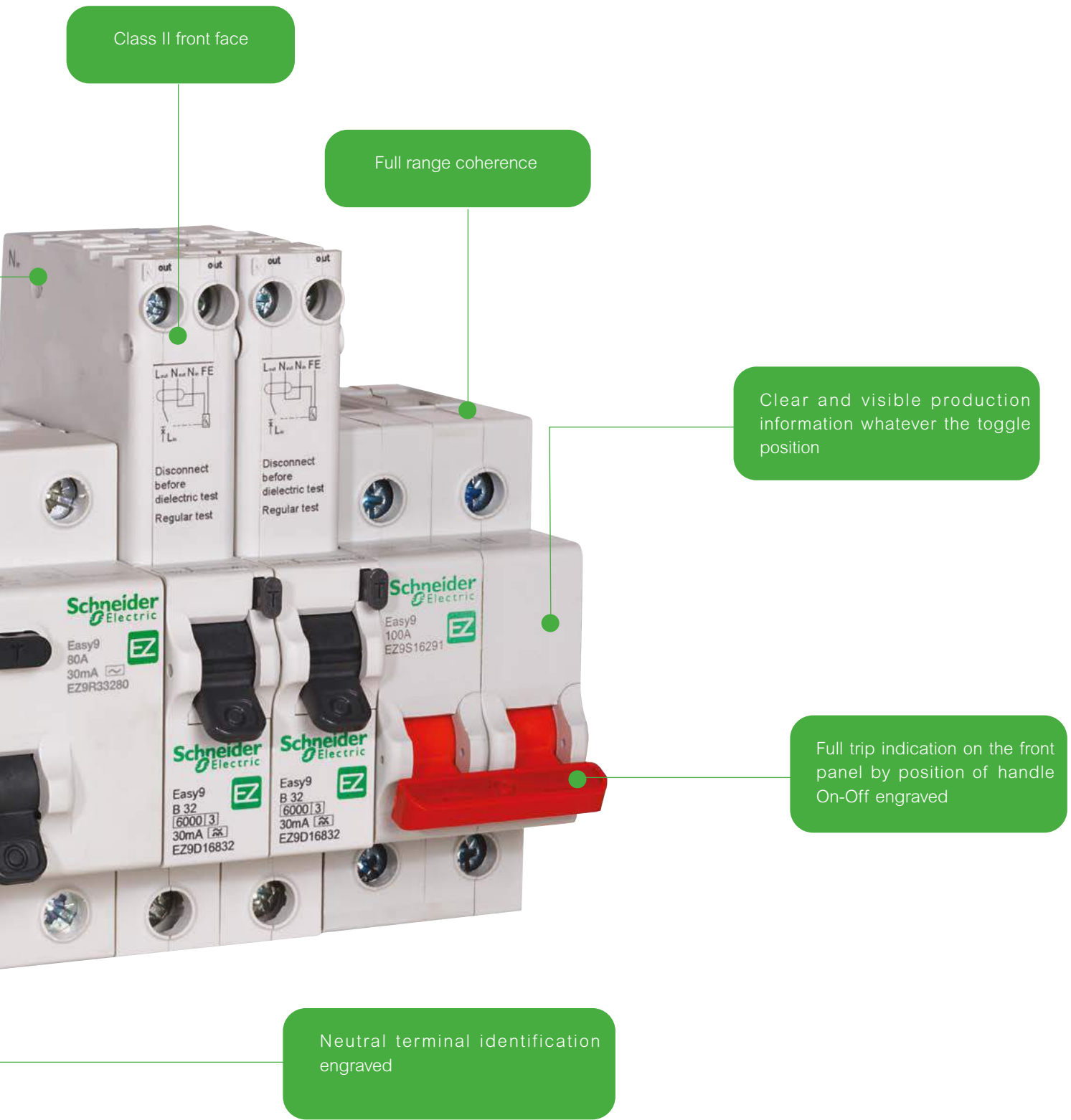

Class II front face

Full range coherence

Clear and visible production information whatever the toggle position

Full trip indication on the front panel by position of handle On-Off engraved

Neutral terminal identification engraved

Easy9

Description



- Metal surface/recessed enclosures
- Multiple cable entry points
- Multiple rear knock out slots
- Secure raised DIN rail
- Earth and neutral blocks fitted as standard
- Secure raised busbar shield
- Earthed front cover
- Reversible door
- Can be mounted horizontally or vertically
- Enclosure colour: white RAL9003
- Neutral bar shields
- Lock accessory
- BSEN 61439-3
- IP3X

Consumer units

Reference	Description	Usable Ways
EZ9E2MCU	2 way metal consumer unit	2
EZ9E4MCU	4 way metal consumer unit	4
EZ9E6MCU	6 way metal consumer unit	6
EZ9E8MCU	8 way metal consumer unit	8
EZ9E12MCU	12 way metal consumer unit	12
EZ9E16MCU	16 way metal consumer unit	16
EZ9E20MCU	20 way metal consumer unit	20

Surge protection consumer units

Reference	Description	Usable Ways
EZ9ESLR7R6CMCU	7+6 metal consumer unit inc 100A SW, SPD, 100A RCCB X 2	13
EZ9ESL3R5R5CMCU	3+5+5 metal consumer unit inc 100A SW, SPD, 100A RCCB X 2	13

Dual RCD consumer units

Reference	Description	Usable Ways
EZ9ER4R4MCU	4+4 metal consumer unit inc 100A SW, 63A RCCB X 2	8
EZ9ER6R6MCU	6+6 metal consumer unit inc 100A SW, 63A RCCB X 2	12
EZ9ER6R6CMCU	6+6 metal consumer unit inc 100A SW, 100A RCCB X 2	12
EZ9ER8R8CMCU	8+8 metal consumer unit inc 100A SW, 100A RCCB X 2	16

Multiple split consumer units - High integrity

Reference	Description	Usable Ways
EZ9ES2R5R5CMCU	2+5+5 metal consumer unit inc 100A SW, 100A RCCB X 2	12
EZ9ES2R7R7CMCU	2+7+7 metal consumer unit inc 100A SW, 100A RCCB X 2	16

Flexible split consumer units

Reference	Description	Usable Ways
EZ9EFS12CMCU	12 way flexible split metal consumer unit inc 100A SW, 100A RCCB X 2	12
EZ9EFS16CMCU	16 way flexible split metal consumer unit inc 100A SW, 100A RCCB X 2	16

Populated consumer units

Reference	Description	Usable Ways
EZ9ER4R4MRE	4+4 kitbox C/W 6 MCB - inc 100A SW, 63A RCCBx2 & 2x6A, 1x16A, 2x32A, 1x40A MCB's	8
EZ9ER6R6MRE	6+6 kitbox C/W 8 MCB - inc 100A SW, 63A RCCBx2 & 3x6A, 1x16A, 3x32A, 1x40A MCB's	12
EZ9ES2R5R5CMRE	2+5+5 kitbox C/W 8 MCB - inc 100A SW, 100A RCCBx2 & 3x6A, 1x16A, 3x32A, 1x40A MCB's	12



PV consumer unit

Reference	Description	Usable Ways
EZ9EPVR6R6CMCU	6+6 dual supply PV metal consumer unit with meter	12

Garage & Shower consumer units

Reference	Description	Usable Ways
EZ9EGARAGE63	Garage unit C/W 63A RCCB and 6 & 16A MCBs	2
EZ9ESHOWER63	Shower unit C/W 63A RCCB and 50A MCB	2

Semi-flush mount frame

Functions

- Reduce obtrusion
- Aesthetic frame
- Neat profile finish

Semi-flush mount frame

Reference	Description	Suitable for
EZ9EFLKIT12	Semi-flush mount frame 12way	12way, 4+4way
EZ9EFLKIT16	Semi-flush mount frame 16way	16way, 6+6way, 2+5+5way
EZ9EFLKIT20	Semi-flush mount frame 20way	20way, 8+8 way, 2+7+7way, . 7+6way, 3+5+5way



Product selector

Consumer units

Reference	Description	Usable Ways
EZ9E2MCU	2 way consumer unit	2
EZ9E4MCU	4 way consumer unit	4
EZ9E6MCU	6 way consumer unit	6
EZ9E8MCU	8 way consumer unit	8
EZ9E12MCU	12 way consumer unit	12
EZ9E16MCU	16 way consumer unit	16
EZ9E20MCU	20 way consumer unit	20

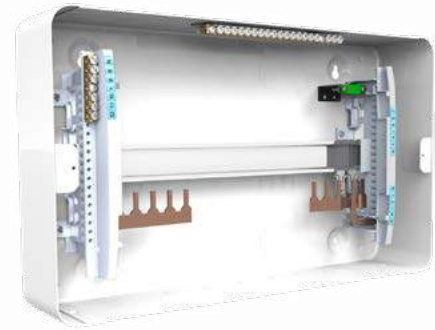

Incomers

Reference	Device	Rating	Description
EZ9S16263	Switch	63A	Switch disconnecter 2P 63A
EZ9S16291	Switch	100A	Switch disconnecter 2P 100A
EZ9R33263	RCCB	63A, 30mA	Residual Current Circuit Breaker 2P 63A 30mA AC-type 230V
EZ9R33291	RCCB	100A, 30mA	Residual Current Circuit Breaker 2P 100A 30mA AC-type 230V
EZ9R46263	RCCB	63A, 30mA	Residual Current Circuit Breaker 2P 63A 30mA A-type 230V



Split load

Reference	Device	Rating	Description
EZ963R30KIT2	Split load RCCB kit	63A, 30mA	63A 30mA Split load kit, inc cables
EZ9100R30KIT2	Split load RCCB kit	100A, 30mA	100A 30mA Split load kit, inc cables

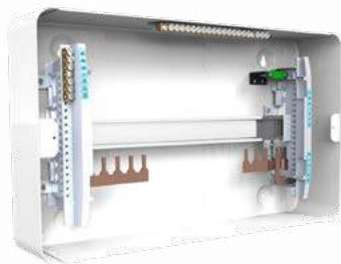

Select consumer units with switch/RCD's fitted

Surge protection consumer unit

Reference	Description	Usable ways	Unprotected ways	RCD1 ways	RCD2 ways
EZ9ESLR7R6CMCU *	7+6 C/W SW, SPD, 100A RCCB X 2	13		7	6
EZ9ESL3R5R5CMCU *	3+5+5 C/W SW, SPD, 100A RCCB X 2	13	3	5	5
* Not to be used on a TT earthing system					

Dual RCD consumer units

Reference	Description	Usable ways	Unprotected ways	RCD1 ways	RCD2 ways
EZ9ER4R4MCU	4+4 C/W SW, 63A RCCB X 2	8		4	4
EZ9ER6R6MCU	6+6 C/W SW, 63A RCCB X 2	12		6	6
EZ9ER6R6CMCU	6+6 C/W SW, 100A RCCB X 2	12		6	6
EZ9ER8R8CMCU	8+8 C/W SW, 100A RCCB X 2	16		8	8

Multiple split consumer units

Reference	Description	Usable ways	Unprotected ways	RCD1 ways	RCD2 ways
EZ9ES2R5R5CMCU	2+5+5 C/W SW, 100A RCCB X 2	12	2	5	5
EZ9ES2R7R7CMCU	2+7+7 C/W SW, 100A RCCB X 2	16	2	7	7

Flexible split consumer units

Reference	Description	Max Usable ways	Max Unprotected ways	Max RCD1 ways	Max RCD2 ways
EZ9EFS12CMCU	Flexible 12 way consumer unit 2+5+5 C/W SW, 100A RCCB X 2	12	4	7	7
EZ9EFS16CMCU	Flexible 16 way consumer unit 2+7+7 C/W SW, 100A RCCB X 2	16	4	9	9

Populated Consumer Unit

Reference	Description	Usable ways	Unprotected ways	RCD1 ways	RCD2 ways
EZ9ER4R4MRE	4+4 kitbox C/W 6 MCB - (2x6A, 1x16A, 2x32A, 1x40A)	8		4	4
EZ9ER6R6MRE	6+6 kitbox C/W 8 MCB - (3x6A, 1x16A, 3x32A, 1x40A)	12		6	6
EZ9ES2R5R5CMRE	2+5+5 kitbox C/W 8 MCB - (3x6A, 1x16A, 3x32A, 1x40A)	12	2	5	5

Semi-flush mount frame

Reference	Description	Suitable for	Suitable for:
EZ9EFLKIT12	EZ9 Semi-flush mount frame 12 way	12way, 4+4way	EZ9E12MCU, EZ9ER4R4MCU, EZ9ER4R4MRE
EZ9EFLKIT16	EZ9 Semi-flush mount frame 16 way	16way, 6+6way, 2+5+5way	EZ9E16MCU, EZ9ER6R6MCU, EZ9ER6R6CMCU, EZ9ER6R6CMRE, EZ9ES2R5R5CMCU, EZ9ES2R5R5CMRE, EZ9EFS12CMCU
EZ9EFLKIT20	EZ9 Semi-flush mount frame 20 way	20way, 8+8 way, 2+7+7way, 7+6way, 3+5+5way	EZ9E20MCU, EZ9ER8R8CMCU, EZ9ES2R7R7CMCU, EZ9EFS16CMCU, EZ9ESLR7R6CMCU, EZ9ESL3R5R5CMCU, EZ9EPVR6R6CMCU

+ Select outgoing devices and accessories

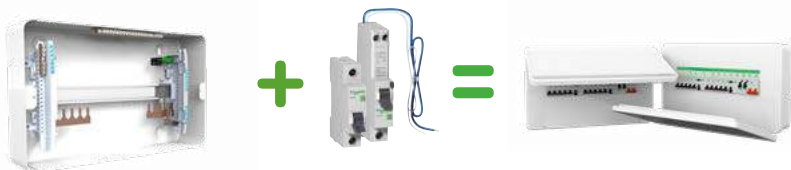

Devices



EZ9S16263



EZ9F16132



EZ9D16832

Incomers

Reference	Description	Current Rating (A)
EZ9S16263	Switch disconnecter 2P 63A 400V	63
EZ9S16291	Switch disconnecter 2P 100A 400V	100
EZ9R33263	RCCB 2P 63A 30mA AC-type 230V	63
EZ9R33291	RCCB 2P 100A 30mA AC-type 230V	100
EZ9R46263	RCCB 2P 63A 30mA A-type 230V	63

Type B MCB's - 1P 6KA 230v

Reference	Description	Current Rating (A)
EZ9F16103	Single pole 3A type B MCB	3
EZ9F16106	Single pole 6A type B MCB	6
EZ9F16110	Single pole 10A type B MCB	10
EZ9F16116	Single pole 16A type B MCB	16
EZ9F16120	Single pole 20A type B MCB	20
EZ9F16125	Single pole 25A type B MCB	25
EZ9F16132	Single pole 32A type B MCB	32
EZ9F16140	Single pole 40A type B MCB	40
EZ9F16150	Single pole 50A type B MCB	50

Type C MCB's - 1P 6KA 230v

Reference	Description	Current Rating (A)
EZ9F66106	Single pole 6A type C MCB	6
EZ9F66110	Single pole 10A type C MCB	10
EZ9F66116	Single pole 16A type C MCB	16
EZ9F66120	Single pole 20A type C MCB	20
EZ9F66132	Single pole 32A type C MCB	32
EZ9F66140	Single pole 40A type C MCB	40
EZ9F66150	Single pole 50A type C MCB	50

RCBO's - 1P 6kA 30mA class type A 230v



Reference	Description	Current Rating (A)
EZ9D16806	Single pole 6A RCBO	6
EZ9D16810	Single pole 10A RCBO	10
EZ9D16816	Single pole 16A RCBO	16
EZ9D16820	Single pole 20A RCBO	20
EZ9D16832	Single pole 32A RCBO	32
EZ9D16840	Single pole 40A RCBO	40
EZ9D16850	Single pole 50A RCBO	50

Surge Protection



EZ9L33620

Reference	Description	Type
EZ9L33620 **	Surge Arrest T2 1P-N 20kA	Type 2
EZ9L33620KIT **	Surge Arrest KIT T2 1P-N 20kA, inc 20A MCB and cable links	Type 2

*Requires a 20amp MCB EZ9F16120

** Not to be used on a TT earthing system



Surge Protection & Residual Current Devices Section 443 and Regulation 411.3.3, 411.3.4

Regulation 411.3.4 requires RCD additional protection for all AC final circuits supplying luminaires in domestic (household) premises.

Protection is available with RCBO and RCCB devices.

Section 443.4 requires protection against transient overvoltages in areas such as co-located buildings, commercial or industrial activity, public services (hospitals, bus stations) and cultural heritage.

That said, SPDs can be justified in virtually all residential applications because the combined cost of equipment at risk will far outweigh the cost of additional protection.

Compliant solutions from the Easy9 range:

- **RCBO devices** provides protection of short-circuits, cable from overloads and persons from electric shocks by direct contact.
- **RCCB devices** provides tripping in case of leakage current only
- **Surge Protection Device and kit** protects against transient overvoltage and lightning strikes.



EZ963R30KIT2



EZ9LKCLIP

Accessories

Reference	Description
EZ963R30KIT2 *	63A 30mA split load kit supplied with cables
EZ9100R30KIT2*	100A 30mA split load kit supplied with cables
EZ916BKIT	Spare 16 way busbar
EZ9ECLMP	Incoming cable clamp
SEDNBP3	Blank plate 3pole
EZ9EBP	Din rail mounted blank pole
EZ9ESP	Label pack
EZ9LKCLIP	EZ9 door lock clip
EZ9ELKBAR	EZ9 universal locking bar
SELA	MCB lock clip

* Can only be used on 8way/12way/16way consumer unit. Cable size 10sqmm.

Technical information



Technical Contents

■ Technical Section

Acti9 Isobar P Technical

Pg 84

KQ Loadcenter Technical

Pg 95

Easy9 Technical

Pg 97

Acti9 Isobar P Technical

Acti9 Isobar P A type distribution boards

BS EN 61439-3 | IEC 61439-3

- Acti9 Isobar is a complete range of single phase distribution boards for commercial and industrial applications
- Standard distribution boards up to 27 ways
- Multi service distribution boards up to 21 ways
- Split metered distribution boards up to 28 ways
- Any outgoing way can be converted to switch the Neutral
- Fully type tested conditional short circuit rating of 16kA to BS EN 61439-3
- High performance MCB 10kA BS EN 60898 15kA BS EN 60947-2 in B, C or D curve single and double pole
- 125A busbar rating*
- Isobar disconnection to BS EN 60947-3 ensuring unused outgoing ways are isolated
- Option of switching outgoing neutral on all boards using distributed neutral kit
- Terminal block for feeding up to 100A
- Range of incomers: switch disconnectors, Residual Current Devices, terminal blocks
- Single pole wireless RCBO
- Single pole wired RCBO
- Full IP2X internal shrouding
- Full range of device accessories and auxiliaries
- Knockouts for cable gland and conduit mixed to suit the installation needs without loss of space
- Split metering options
- Connectivity with MCB and RCBO single phase wireless energy sensors

* For typical assembly configuration ratings (I_{nA}) with incomers fitted consult us



Main Characteristics Alternating Current (AC) 50Hz		
withstand	110V	230/240V
Conditional	10kA	10kA

Technical data standard, multi service, split metered Acti9 Isobar

insulation voltage (Ui)	500V		500V	
Pollution degree	3		3	
Rated impulse withstand voltage (Uimp)	6kV		6kV	
Current rating (A*)	direct connection	125A	terminal block	125A
	switch disconnector	125A	power switch	125A
	RCCB			
	sensitivites (mA)	30, 100, 300, 300TD, 100A		
Degree of protection (IEC 60529)	external IP3X			
	internal IP2X			
Endurance (O-C) Isobar switch disconnector	3000			
Overvoltage category	IV			
Operating temperature*	-35 to +70°C			
Storage teperature	-40 to +80°C			
* For typical assembly configuration ratings (I_{nA}) with incomers fitted consult us				
Connections				
Rating	Tightening torque	Copper lugs	Cables bare	Device
125 amp	3.5Nm	■	50mm ²	DIN switch disconnector
125 amp	3.5Nm	■	50mm ²	Terminal block
100 amp	3.5Nm	■	35mm ²	RCCB

Acti9 Isobar P B type distribution boards

BS EN 61439-3 | IEC 61439-3

- Acti9 Isobar is a complete range of three phase distribution boards for commercial and industrial applications
- Standard distribution boards up to 24 ways
- Meter ready distribution boards up to 24 ways
- Split metered distribution boards up to 22 ways
- Any outgoing way can be converted to switch the Neutral
- Fully type tested conditional short circuit rating of 25kA to BS EN 61439-3
- High performance MCB 10kA BS EN 60898 15kA BS EN 60947-2 in B, C or D curve 1, 2, 3, 4 pole
- 250A busbar rating*
- Isobar disconnection to BS EN 60947-3 ensuring unused outgoing ways are isolated
- Option of switching outgoing neutral on all boards using distributed neutral kit
- Terminal block for feeding up to 100A
- Range of incomers: switch disconnectors, Residual Current Devices, terminal blocks, MCCB
- Single pole Wireless RCBO
- Single pole wired RCBO
- Full IP2X internal shrouding
- Full range of device accessories and auxiliaries
- Knockouts for cable gland and conduit mixed to suit the installation needs without loss of space
- Removable insulated pan assembly
- Fully shrouded neutral
- Split neutral bars
- Removable gland plates
- Optional metering and contactor on incoming
- Metered extension enclosures
- Connectivity with MCB, RCBO and MCCB PowerTag wireless energy sensors

* For typical assembly configuration ratings (I_{nA}) with incomers fitted consult us



Alternating current (AC) 50Hz			
withstand	230/240V	400V	415V
Conditional	25kA	25kA	25kA
Unconditional	25kA/50ms	25kA/50ms	25kA/50ms
	17kA/200ms	17kA/200ms	17kA/200ms
Direct current (DC)			
	24V	48V	
Unconditional	25kA/50ms	25kA/50ms	

Technical data standard, meter ready, split metered

Main characteristics		230/240V	400V	415V
Withstand	Conditional	25kA	25kA	25kA
	Unconditional	25kA/50ms	25kA/50ms	25kA/50ms
		17kA/200ms	17kA/200ms	17kA/200ms
Insulation voltage (Ui)		500VAC	500VAC	500VAC
Pollution degree		3	3	3
Rated impulse withstand voltage (Uimp)		6kV	6kV	6kV
Current rating (A*)	direct connection	125/250	6kV	6kV
	Switch disconnecter	125	DIN mounted power switch	
		160-200-250	Interpact	
	MCCB	100-160-200-225-250		
Degree of protection		external IP3X		
(IEC 60529)		internal IP2X		
Endurance (O-C) Isobar switch disconnecter		3000		
Overvoltage category		IV		
Operating temperature*		-35 to +70°C		
Storage temperature		-40 to +80°C		
* For typical assembly configuration ratings (I_{nA}) with incomers fitted consult us				

Main characteristics heavy duty

According to BE EN 61439-3		230/240V	400V	415V
Withstand	Conditional	25kA	25kA	25kA
	Unconditional	25kA/50ms	25kA/50ms	25kA/50ms
		17kA/200ms	17kA/200ms	17kA/200ms
Insulation voltage (Ui)		500VAC		
Pollution degree		3	3	3
Rated impulse withstand voltage (Uimp)		6kV		
Current rating (A*)		125A		
Degree of protection		external IP55		
(IEC 60529)		internal IP20		
Endurance (O-C) Isobar switch disconnecter		3000		
Overvoltage category		IV		
Operating temperature*		-35 to +70°C		
Storage temperature		-40 to +80°C		
* For typical assembly configuration ratings (I_{nA}) with incomers fitted consult us				
Anti condensation measures should be taken if installed in an external location				

Acti9 iC60H circuit breakers (curve B, C, D)



- Increased product service life thanks to:
- Overvoltage resistance by high level of industrial performances conception (pollution degree, rated impulse withstand voltage and insulation voltage),
- High performance limitation (see limitation curves),
- Fast closing independent of the speed of actuation of the toggle.
- Remote indication, open/closed/tripped, by optional auxiliary contacts.
- Top or bottom electrical feeding.

Acti9 iC60H circuit breakers (B, C, D)

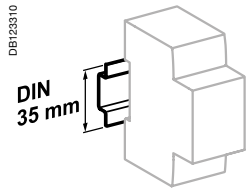

Clip on DIN rail 35 mm.

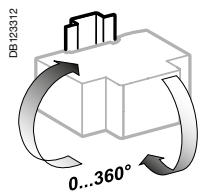

Indifferent position of installation.

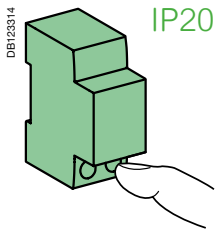

IP20

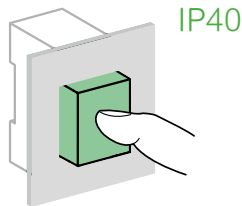

IP40

Technical data

Main characteristics		
According to IEC/EN 60947-2		
Insulation voltage (Ui)		500 V AC
Pollution degree		3
Rated impulse withstand voltage (Uimp)		6 kV
Thermal tripping	Reference temperature	50°C
Magnetic tripping	B curve	4 In ± 20 %
	C curve	8 In ± 20 %
	D curve	12 In ± 20 %
Utilization category		A
According to IEC/EN 60898-1		
Limitation class		3
Rated making and breaking capacity of an individual pole (Icn1)		Icn1 = Icn
Additional characteristics		
Breaking capacity under 1 pole with IT 380-415 V isolated neutral system (case of double fault)	40 A	4 kA
	50/63 A	3 kA
Degree of protection (IEC 60529)	Device only	IP20
	Device in modular enclosure	IP40 Insulation class II
Endurance (O-C)	Electrical	10,000 cycles
	Mechanical	20,000 cycles
Overvoltage category (IEC 60364)		IV
Operating temperature		-35°C to +70°C
Storage temperature		-40°C to +85°C
Tropicalization (IEC 60068-1)		Treatment 2 (relative humidity 95 % to 55°C)

Dimensions (mm)

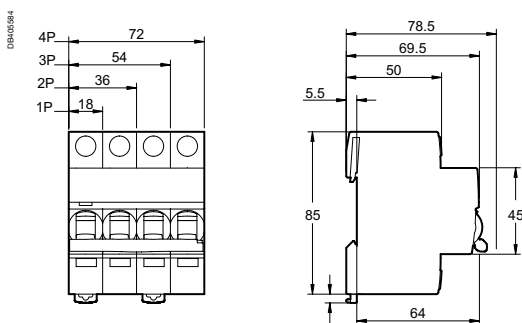

Weight (g)

Circuit breaker	
Type	iC60H
1P	125
2P	250
3P	375
4P	500

Acti9 iC60H PoN RCBO 10, 30 and 100 mA

IEC 61009-1, IEC 61009-2-2, BS EN 61009-1 Type A 

The single-phase iC60H RCBO PoN's self-contained residual current device carries out complete protection of final circuits:

- Protection against short-circuits and cable overloads
- Protection of persons against electric shock by direct contact (10, 30 mA sensitivities)
- Protection of persons against electric shock by indirect contact (100 mA sensitivity)
- Protection of equipment against fires set by leakage currents (100 mA sensitivity)
- The neutral is not interrupted when the device is tripped. Hence iC60H RCBO PoN can be used on most circuits, except for the ones operating under TT or IT earthing systems.
- iC60H RCBO PoN device carries out a quick and reliable plug on installation with FE blade and Neutral jaw

Alternating current (AC) 50/60 Hz		
Breaking capacity (Icn) according to IEC 61009-1		
		Voltage (Ue)
Ph/N		240 V
Rating (In)	6 to 45 A	10000 A

Technical data

Main characteristics		iC60H PON RCBO
Insulation voltage (Ui)		400 V AC
Rated impulse withstand voltage (Uimp)		4 kV
Rated residual operating current (IΔn)		10, 30, 100 mA
Magnetic tripping	B Curve	Between 3 and 5 in
	C curve	Between 5 and 10 in
Thermal tripping	Reference temperature	50°C
Limitation class		3
Surge current withstand (8/20 μs) without tripping		250 A
Rated nominal breaking capacity (Icn)		10,000 A
Phase/earth rated residual breaking and making capacity (IΔm)		7,500 A

Additional characteristics		
Plug-on functional earth and neutral connection		
Degree of protection	Device only	IP20
	Device in modular enclosure	IP40 Insulation class II
Endurance (O-C)	Electrical	5,000 cycles
	Mechanical	20,000 cycles
Operating temperature		-15°C to +60°C
Storage temperature		-40°C to +85°C
Tropicalization		Treatment 2 (relative humidity: 95 % at 55°C)

Dimensions (mm)

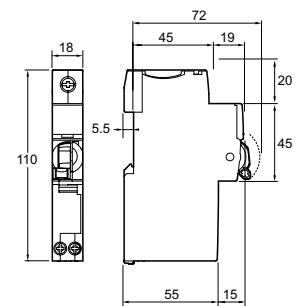

iC60H RCBO

Acti9 iC60H PoN RCBO 10, 30 and 100 mA

IEC 61009-1, IEC 61009-2-2, BS EN 61009-1 Type A 

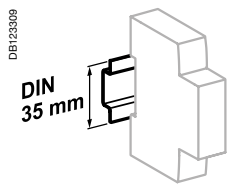

Clip on DIN rail 35 mm.

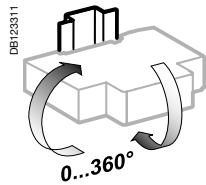

Indifferent position of installation.

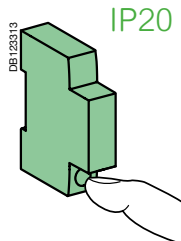

IP20

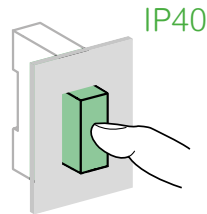

IP40

Weight (g)

iC60 RCBO	
iC60H PoN RCBO	156

VISI-TRIP window

- Fault tripping is indicated by a red mechanical indicator on the front face

Test push-button

Positive contact indication

- The presence of the green strip guarantees physical opening of the contacts and allows operations to be performed on the downstream circuit in complete safety

Strong FE blade

Robust neutral jaw

Autolock locking clip

Padlocking device

- Increased product service life thanks to fast closing independent of the speed of actuation of the toggle.
- Remote indication, open/closed/tripped, by optional auxiliary contacts.

Acti9 iC60H RCBO 10, 30 and 100 mA

IEC 61009-1, IEC 61009-2-2, BS EN 61009-1 Type A 

- The single phase iC60H RCBO's self contained Residual Current Device carries out complete protection of final circuits:
- Protection against short circuits and cable overloads
- Protection of persons against electric shock by direct contact (10, 30 mA sensitivities),
- Protection of persons against electric shock by indirect contact (100 mA sensitivity),
- Protection of equipment against fires set by leakage currents (100 mA sensitivity).
- The neutral is not interrupted when the device is tripped. Hence iC60H RCBO can be used on most circuits, except for the ones operating under TT or IT earthing systems when the neutral needs to be isolated.
- Increased product service life thanks to fast closing independent of the speed of actuation of the toggle.
- Remote indication, open/closed/tripped, by optional auxiliary contacts.

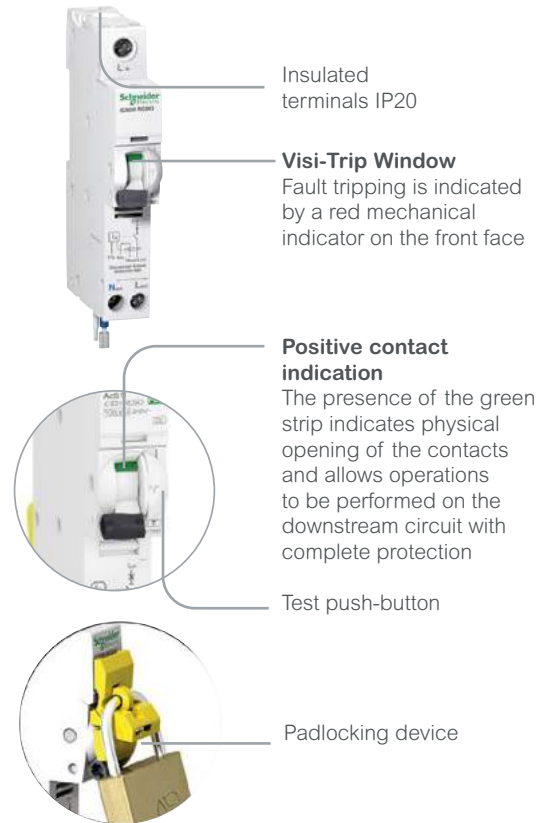

Alternating current (AC) 50/60 Hz		
Breaking capacity (Icn) according to IEC 61009-1		
	Voltage (Ue)	
Ph/N	110 V	240 V
Rating (In)	6 to 45 A	10000 A

Technical data

Main characteristics		iC60H RCBO
Insulation voltage (Ui)		400 V AC
Rated impulse withstand voltage (Uimp)		4 kV
Rated residual operating current (IΔn)		10, 30, 100 mA
Thermal tripping	Reference temperature	50°C
Limitation class		3
Surge current withstand (8/20 μs) without tripping		250 A
Rated nominal breaking capacity (Icn)		10,000 A
Phase/earth rated residual breaking and making capacity (IΔm)		7,500 A
Additional characteristics		
Degree of protection	Device only	IP20
	Device in modular enclosure	IP40
Endurance (O-C)	Electrical	5,000 cycles
	Mechanical	20,000 cycles
Operating temperature		-15°C to +60°C
Storage temperature		-40°C to +85°C
Tropicalization		Treatment 2 (relative humidity: 95 % at 55°C)

Dimensions (mm)

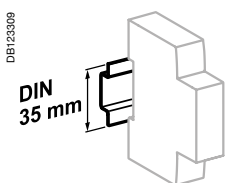
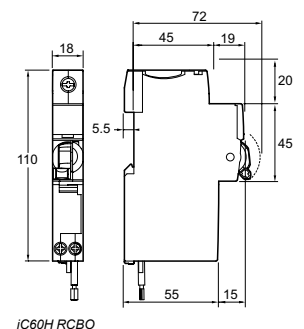

Clip on DIN rail 35 mm.

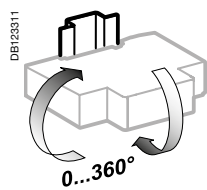

Indifferent position of installation.

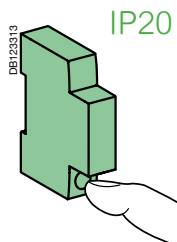

IP20

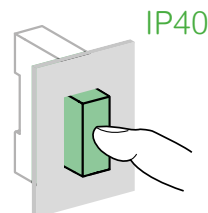

IP40

Weight (g)

iC60 RCBO	
iC60H RCBO	205

Protection / Circuit protection

Arc fault detection device iARC



Test button

■ For device self-diagnostic

Positive break indication

■ A green strip on the handle indicates that all the poles are open for insulation

Red square indicator

■ Fire hazard tripping indication via a "red" status indicator

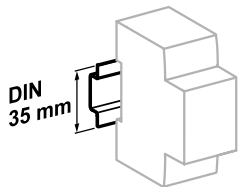

Clip on DIN rail 35 mm.

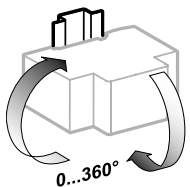

Indifferent position of installation.

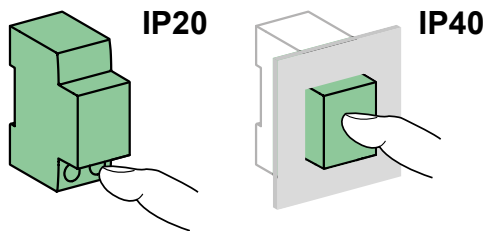

Technical data

Main characteristics							
Tripping time/arc current value with $U_n = 230\text{ V AC}$ (to IEC/EN 62606)	Arc current	2.5 A	5 A	10 A	16 A	25 A	32 A
	Max. operating time	1 s	0.5 s	0.25 s	0.15 s	0.14 s	0.12 s
Overvoltage tripping time (neutral conductor break)	400 V AC, 200 ms						
Insulation voltage (U_i)	400 V AC						
Degree of pollution	2						
Rated impulse withstand voltage (U_{imp})	4 kV						
Rated making and breaking capacity (I_m)	500 A						
Overvoltage category	III						
Coordinated with an upstream circuit breaker	Max. rating	32 A (A9FDD232)					
	Curve	B or C					
	Rated breaking capacity (I_{cn})	Up to 10,000 A					
Additional characteristics							
Degree of protection	Device alone	IP20					
	Device in a modular enclosure	IP40 Insulation class II					
Endurance (O-C)	Electrical	10,000 cycles					
	Mechanical	20,000 cycles					
Operating temperature	-25°C to +40°C						
Storage temperature	-40°C to +85°C						
Tropicalization (to IEC/EN 62606)	Severity B (to IEC 60068-2-30) during 28 days						

Weight (g)

Arc fault detection device	
Type	iARC
1P+N 32A	200

Dimensions (mm)

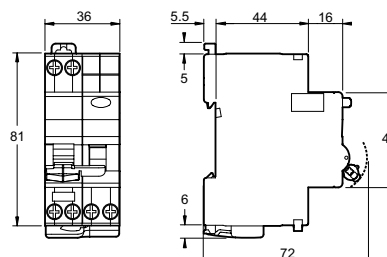

KQ Loadcenter Technical

iKQ MCB

- Plug on connection
- Complies with BS EN 60898
- Breaking capacity 10kA
- Class 2 front face
- Padlocking device for locking on or off
- Tripped fault indication
- Insulated shuttered terminals
- IP 20 finger safe terminals



iKQ RCBO

- Plug on connection
- B and C curve
- Type A as standard 
- Complies with BS EN 61009
- Breaking capacity 10kA
- Class 2 front face
- padlocking device for locking on or off
- Will trip even if neutral is lost
- Tripped fault indication
- Insulated shuttered terminals
- IP 20 finger safe terminals

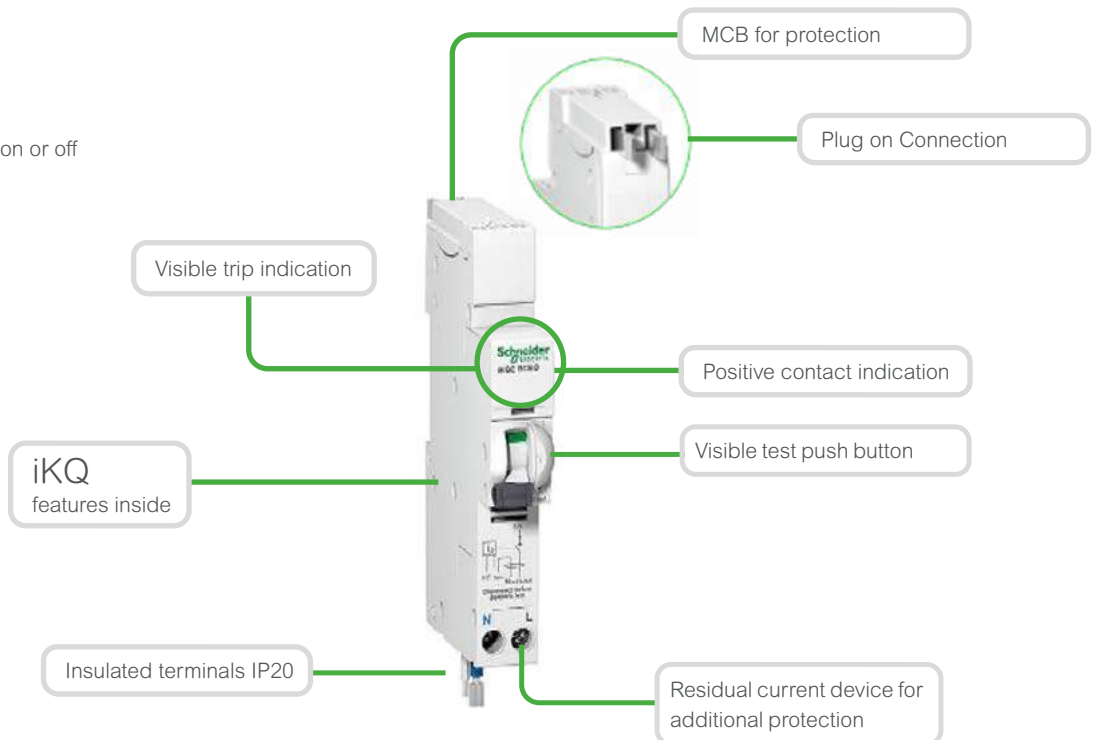





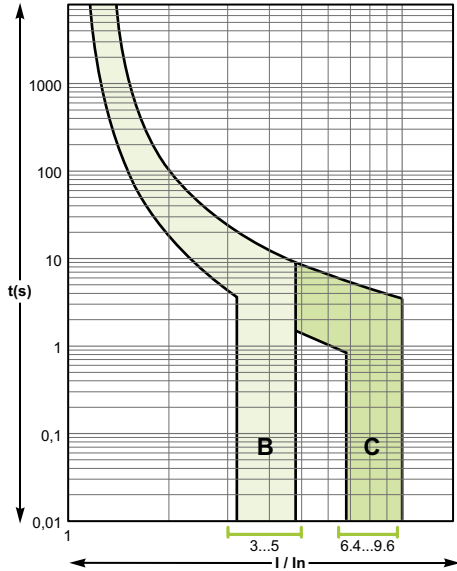





Easy9 Technical

Time current tripping curves Miniature Circuit Breakers



MCB selection chart for household appliances

Appliance		Capacity	MCB rating (A)	Tripping curves
Air conditioner		1 ton	16	"C"
		1.5 ton	20	
		2 ton	20	
		3 ton	25	
Refrigerator		165 litres	2	"C"
		285 litres	2	
Water heater		1 kW	6	"B"
		3 kW	16	
Electric kettle		1.5 kW	10	"B"
Food processor (50 % load)		200 W	1	"C"
Vacuum cleaner		50 W	0.5	
Toaster		1.2 kW	6	"B"
Cooking range		750 W	4	
		2 kW	10	
		4.5 kW	25	
Room heater		1 kW	6	"B"
		2 kW	10	
Washing machine		300 W	2	"C"
		1.3 kW	10	
Electric iron		750 W	6	"B"
		1.25 kW	6	



Miniature Circuit Breakers

Selection of circuit breakers according to the cables to be protected (BS 7671)

- PVC-insulated, copper, flexible or rigid cable.
- Ambient temperature:
 - 30°C in the open air (methods A, B, C, E)
 - 20°C if buried (method D),
- For other situations, refer to BS 7671 standard (or UK wiring regulations).

Function

- Protection from short circuits.
- Protection of cable from overload.

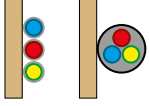
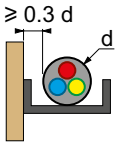
MCB current rating		Single phase circuit							
Cable cross section (in mm ²)		1.5	2.5	4	6	10	16	25	35
Type of installation		Maximum rating of the circuit breaker used there (in Ampere)							
A: in conduit or directly in thermally insulated wall, moulding, architrave, window frame									
Single core		10	16	25	32	40	50	80	80
Multicore		10	16	25	32	40	50	70	80
B: in conduit in a wall, in conduit trunking or cable duct on a wall, in building cavity									
Single core		16	20	32	40	50	70	100	125
Multicore		16	20	25	32	50	50	80	80
C: direct on a wall, suspended from ceilings, on unperforated cable tray, in masonry wall									
Single core or multicore		16	25	32	40	63	80	100	125
D: in conduit in the ground									
Multicore or single core		20	25	32	40	50	70	80	80
D: directly in the ground									
Multicore or single core		20	25	32	40	63	80	100	125
E: in free-air, on cable ladder, on perforated cable tray									
Multicore		20	25	40	40	70	80	100	125

Residual Current Devices

Function

- Protection of persons against electric shock by direct contact (30 mA).
- Protection of installations against the risk of fire (300 mA).
- Protection of persons against electric shock by indirect contact (100 mA to 300 mA).



Operating principle

Protection from electric shocks by direct contact

- Protection of persons against electric shock by direct contact (30 mA).
- Protection of installations against the risk of fire (300 mA).
- Protection of persons against electric shock by indirect contact (100 mA to 300 mA).

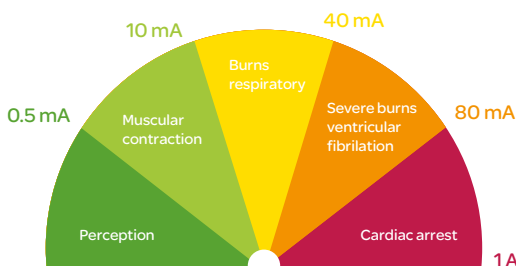
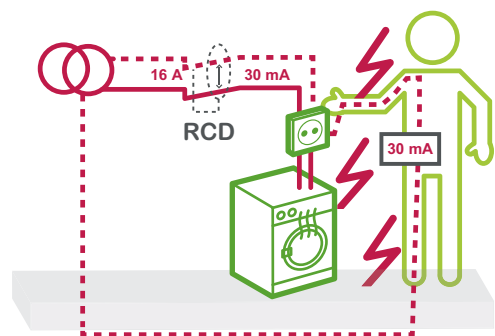

Research worldwide shows that the intensity of current flowing through the body determines the extent and severity of an electric shock.

By measuring the intensity difference between live and neutral conductors, RCDs actually detect the current flowing through the human body. If this current reaches the 30 mA limit, the RCD trips within a few milliseconds, so preventing injury or worse.

- Injuries become serious when currents exceed 40 to 50 mA during one second.
- Theoretically, a 150 mA current flows through the body when a person touches a 230 V energised conductor under dry conditions.

Check RCDs regularly

Test



Testing the RCD every 3 months enables detection of any event that may have impaired its operation



Residual Current Devices

Selection

Residual current sensitivity

Protection from	Residential	Non-residential	Sensitivity
Electric shocks by direct contact			
	Mandatory protection for all socket outlets Mandatory protection for all electrical equipment in bathroom Recommended for lighting circuits	Mandatory protection for all socket outlets Mandatory protection for all equipment located close to water points	30 mA 10 mA for all applications where required by the standard (e.g.: jacuzzi, swimming pools, etc.)
Fire ignited by leakage current			
	Recommended in old buildings (presence of dust or moisture)	Mandatory in all locations under risk of fire or explosion Recommended in all premises under presence of dust, moisture, chemical agents.	300 mA
Electric shock by indirect contact			
	All circuits in case of "TT" earthing system	All circuits in case of "TT" earthing system	100 mA or 300 mA

Current rating: shall not be in excess of upstream MCB current rating

Requirements from wiring regulation (411.3.3)

Protection by means of a Residual Current protective Device (RCD), shall be provided for:

- Socket outlets with a rated current not exceeding 20 A, mobile equipment with a current rating not exceeding 32 A for use outdoors.
- In rooms containing a bath or a shower.
- Cables in walls/ partitions
- EV charging circuits
- Swimming pools

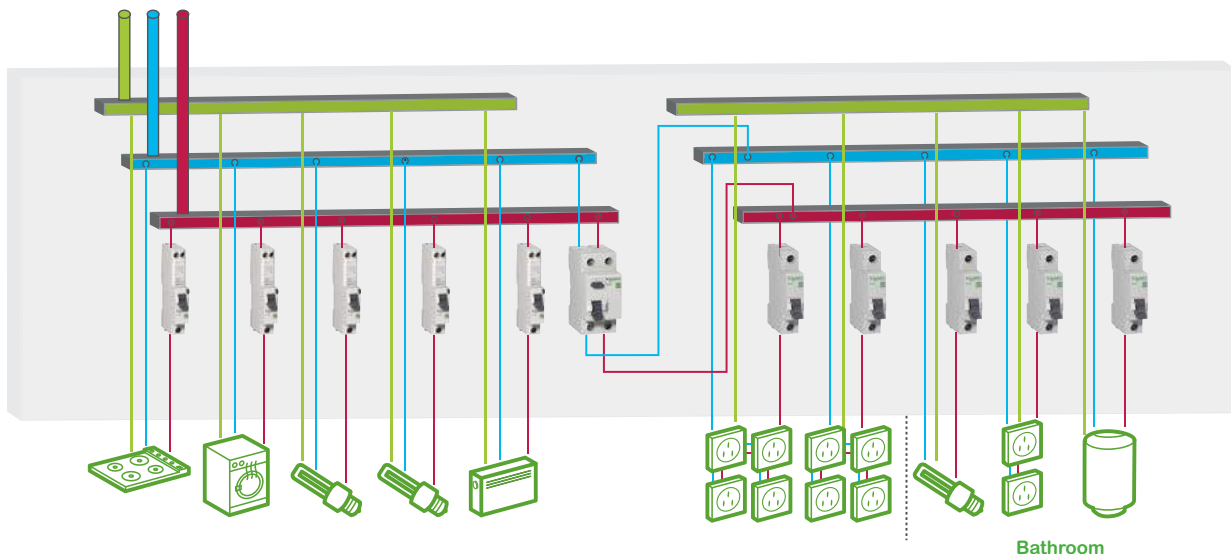

Switch-disconnectors



Positive contact indication
 Suitable for isolation according to BSEN 60947-3 standard
 Manual control on front face by O-I lever

Characteristics

Main characteristics			
Operating category	AC-22 A		
Permissible rated short-time withstand current (Icw)	12 Ie, 1 second		
Conditional rated short-circuit current (Inc)	5000 A		
Rated short-circuit closing current (Icm)	15 Ie		
Additional characteristics			
Degree of protection (IEC 60529)	Device only	IP20	
Endurance (O-C)	Mechanical	40 -100 A	8500 cycles
	Electrical	40-100 A	1500 cycles
Operating temperature	-5°C to +55°C		
Storage temperature	-5°C to +70°C		
Tropicalisation (IEC 60068-1)	Treatment 2 (relative humidity 95 % to 55°C)		

Dimensions (mm)

Weight (g)	
Type	Easy9 switch-disconnector
2P	175

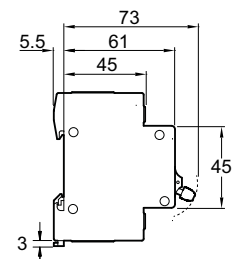
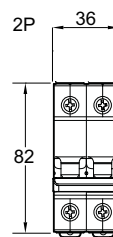

Certified compliant BSEN60947-3

Connection

Rigid copper cables	
≤ 50 mm ²	Tightening torque: 3.5 Nm
Flexible copper cables	
≤ 35 mm ²	Tightening torque: 3.5 Nm

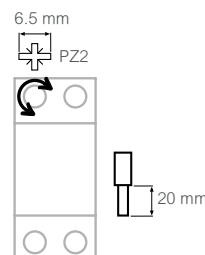

RCCB Residual Current Circuit Breakers



+ Positive contact indication.
 Fault tripping indication on the front panel by the position of the handle (O - I engraved)

Characteristics

Main characteristics		
Rated impulse withstand voltage (Uimp)	4 kV	
According to IEC 61008-1		
Making and breaking capacity (Im/IΔm)	500 A	
Additional characteristics		
Degree of protection (IEC 60529)	Device only	IP20
Hazardous substances		RoHS 2003 compliant
Tropicalisation (IEC 60068-1)	Treatment 2 (relative humidity 95 % to 55°C)	

Passive, will not trip in the event of a voltage loss

Certified compliant BSEN61008-1

Weight (g) and dimensions (mm)

Weight (g)	
Type	Easy9 RCCB
2P	195

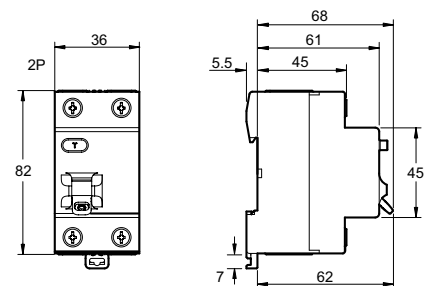

Connection

Rigid copper cables	
1 to 35 mm ²	Tightening torque: 3.5 Nm
Flexible copper cables	
1 to 25 mm ²	Tightening torque: 3.5 Nm

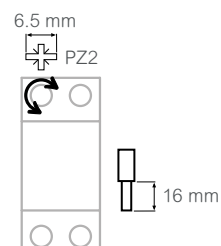

Miniature Circuit Breakers 6 kA



Fault tripping indication on the front panel by the position of the handle (O - I engraved)

Characteristics

Main characteristics	
Voltage rating (Ue)	230/400 V AC
Operating frequency	50/60 Hz
Electrical feeding	By the top and bottom
Additional characteristics	
Degree of protection (IEC 60529)	IP20
Hazardous substances	RoHS 2003 compliant
Tropicalisation (IEC 60068-1)	Treatment 2 (relative humidity 95 % to 55°C)

Additional feature

According to EN 60898-1		
Breaking capacity (Icn)		
Ph/N	230 V AC	6000 A
Additional characteristics		
Endurance (O-C)	Electrical	4,000 cycles
	Mechanical	10,000 cycles
Operating temperature	-5°C to +60°C	
Storage temperature	-40°C to +85°C	

Certified compliant BS EN 60898-1

Weight (g) and dimensions (mm)

Weight (g)	
Type	Easy9 MCB
1P	100

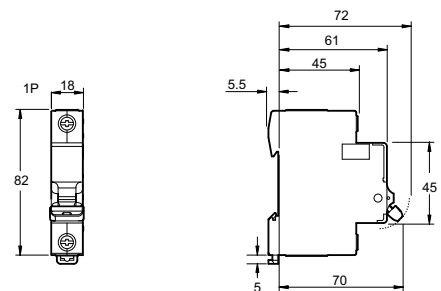

Connection

Rigid copper cables		
3 to 25 A	1 to 25 mm ²	Tightening torque: 2 Nm
32 to 50 A	1 to 35 mm ²	Tightening torque: 3.5 Nm
Flexible copper cables		
3 to 25 A	1 to 16 mm ²	Tightening torque: 2 Nm
32 to 50 A	1 to 25 mm ²	Tightening torque: 3.5 Nm

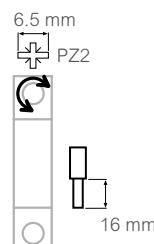

RCBO Residual Current Devices 6 kA

Type A 

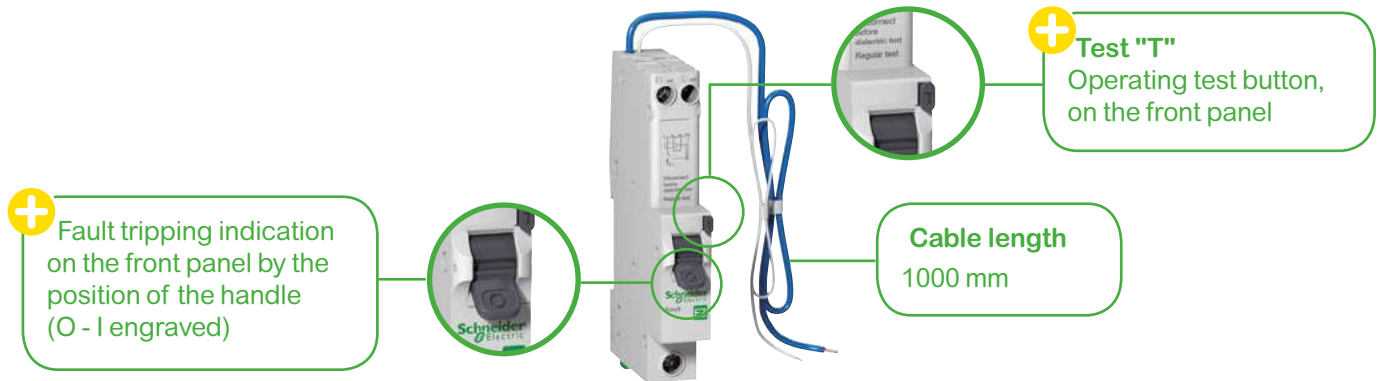

Characteristics

Main characteristics		
Endurance (O-C)	Electrical	4000 cycles
	Mechanical	10000 cycles
Passive, will not trip in the event of a voltage loss		
Additional characteristics		
Degree of protection	Device only	IP20
Overvoltage category (IEC 60364)		IV
Operating temperature		-15°C to +60°C
Storage temperature		-40°C to +85°C
Hazardous substances		RoHS 2003 compliant
Tropicalisation (IEC 60068-1)		Treatment 2 (relative humidity 95 % to 55°C)

Weight (g) and dimensions (mm)

Weight (g)	
Type	Easy9 RCBO
1P+N	180

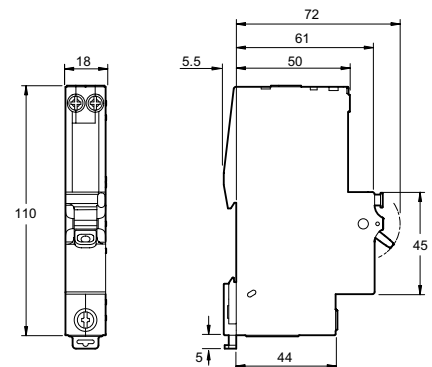

Certified compliant BS EN 61009-1

Connection

Rigid copper cables		
L in	1 to 25 mm ²	Tightening torque: 2 Nm
L and N out	1 to 16 mm ²	Tightening torque: 2 Nm
Flexible copper cables		
L in	1 to 16 mm ²	Tightening torque: 2 Nm
L and N out	1 to 10 mm ²	Tightening torque: 2 Nm

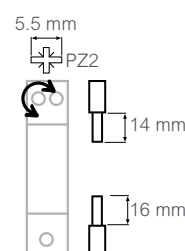

Surge protection device Type 2

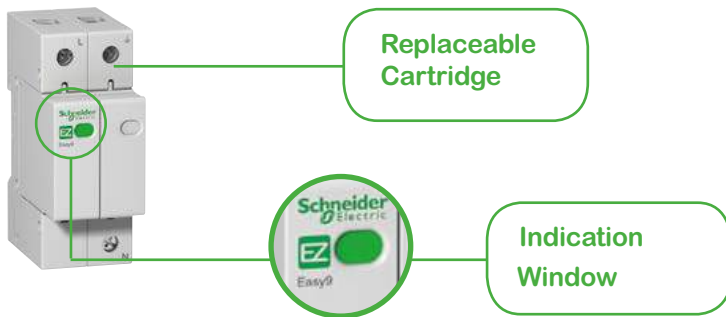

Characteristics

Main characteristics		
Network maximum voltage	Ph / N	230 V, 50/60 Hz
Additional characteristics		
Degree of protection (IEC 60529)	Device only	IP20
	Device in modular enclosure	IP40
Storage temperature		-5°C to +70°C
Operating temperature		-5°C to +60°C

Connection

Rigid copper cables	
5 to 35 mm ²	Tightening torque: 2.5 N.m
Flexible copper cables	
5 to 25 mm ²	Tightening torque: 2.5 N.m

Not to be used with TT earthing systems

Certified compliant with IEC 61 643-11 type 2

Weight (g) and dimensions (mm)

Type	
Type	Easy9 SPD
1P+N	188

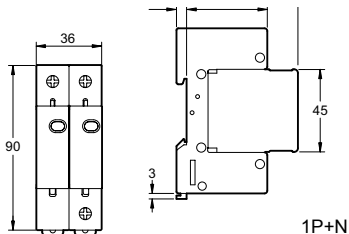

Wiring diagram

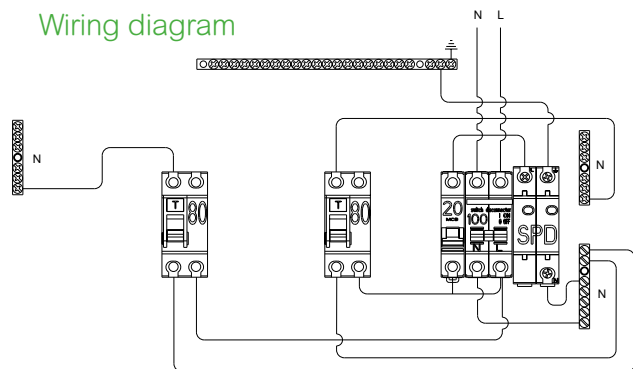

1P+N Easy9 surge arrester

Maximum discharge current (max)	Nominal discharge current (In)	Voltage protection level (Up)	EZ9L33620*
20 kA	10kA	1.3 kV	
Width in 9-mm modules	4		

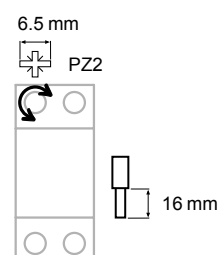

*Requires a 20amp MCB (EZ9F16120) or order surge protection kit (EZ9L33620KIT) c/w MCB and cables.

PV consumer Unit

Includes; 100A Main Switch, 2 x 100A RCCBs and 100A generation isolation Switch with energy generation meter

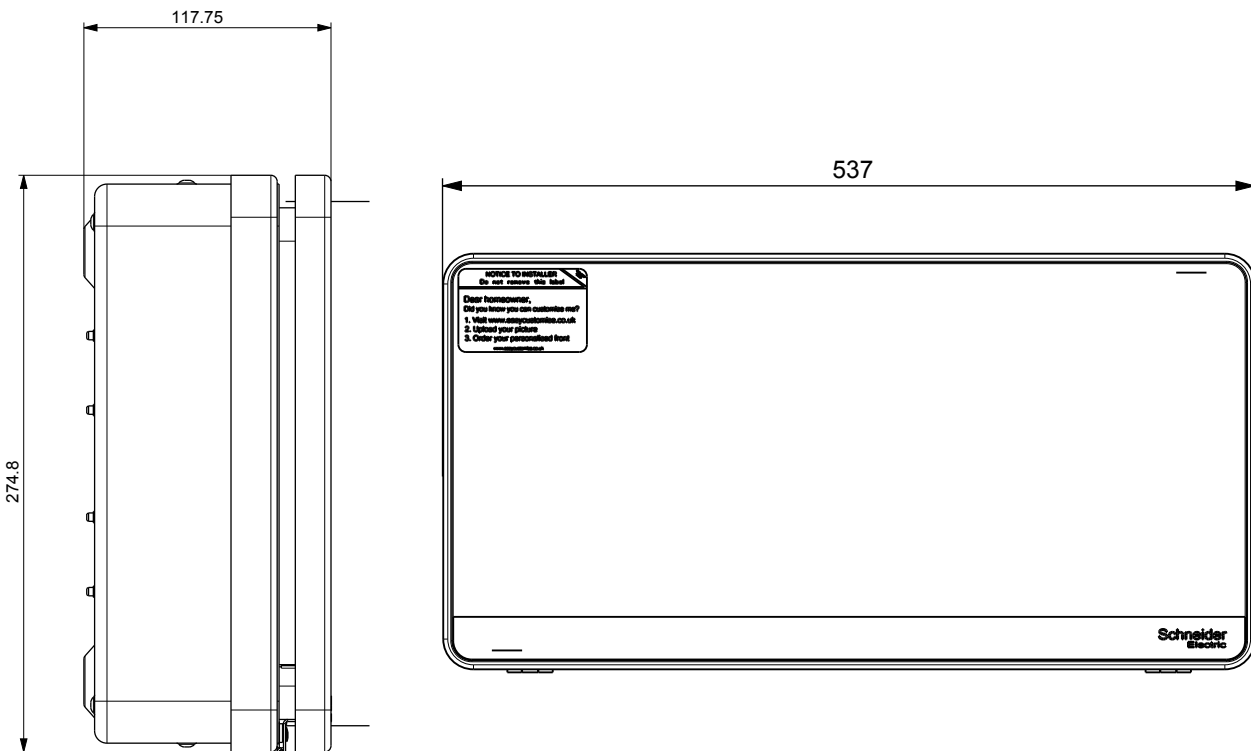
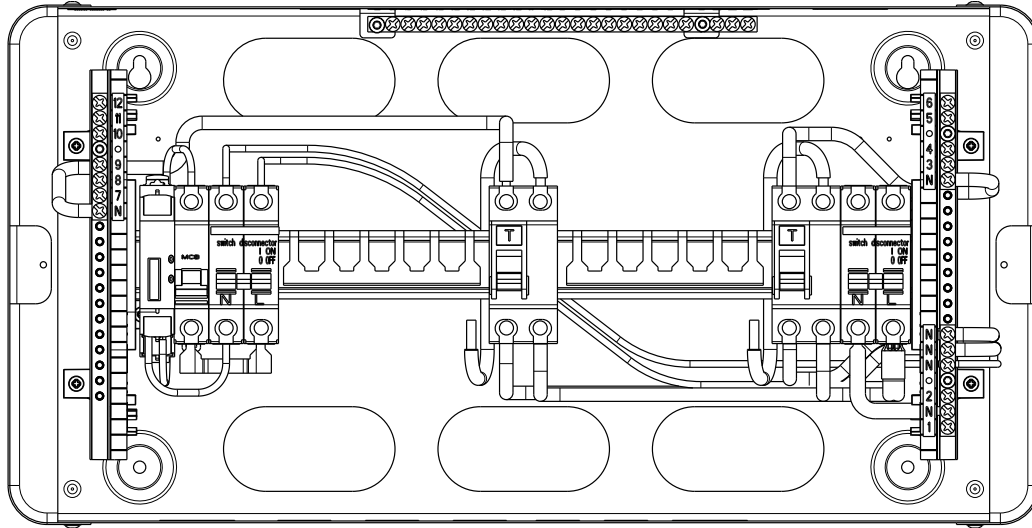



Dimensions and weights



Dimensions and weights

Contents

■ Dimensions Section

Acti9 Isobar P dimensions and weights	Pg 111
KQ Loadcenter dimensions and weights	Pg 116
Easy9 dimensions and weights	Pg 121

Acti9 Isobar P Dimensions

Acti9 Isobar A type distribution boards

Part Number	A	B	C	D	E
SEA9APN2	200	300	117	245	114.8
SEA9APN6	273	300	117	245	166.8
SEA9APN10	345	300	117	245	238.8
SEA9APN14, SEA9APN616MS, SEA9APN108MS	417	300	117	245	310.8
SEA9APN18,SEA9APN6S6, SEA9APN624MS, SEA9APN1016MS, SEA9APN148MS	489	300	117	245	382.8
SEA9APN27, SEA9APN10S10, SEA9APN1432MS	417	570	117	515	310.8
SEA9APN14S14	470	700	140	602	380

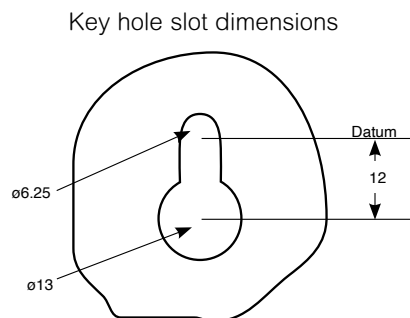
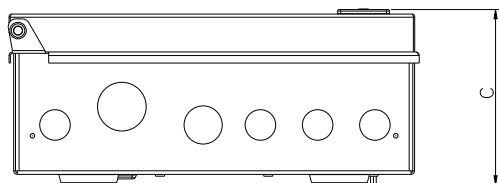
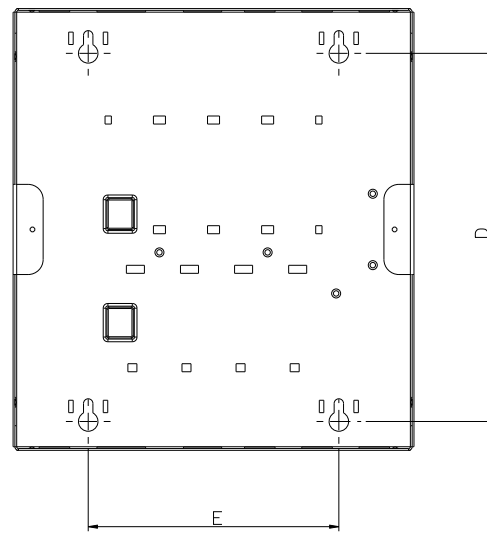
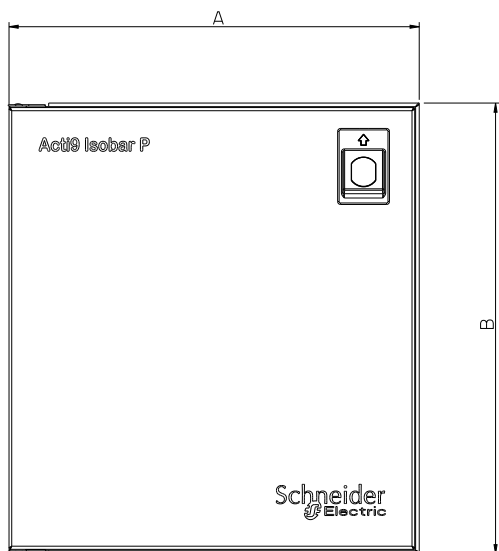

Acti9 Isobar B type distribution boards

Part number	A	B	Weight
SEA9BPN4, SEA9BPN6, SEA9BPN6M	484	386	10.5Kg
SEA9BPN8, SEA9BPN8M	538	440	11.0Kg
SEA9BPN12, SEA9BPN12M	700	602	13.5Kg
SEA9BPN16, SEA9BPN16M	808	710	16.0Kg
SEA9BPN18, SEA9BPN18M	862	764	16.2Kg
SEA9BPN24, SEA9BPN24M	1024	926	22.0Kg

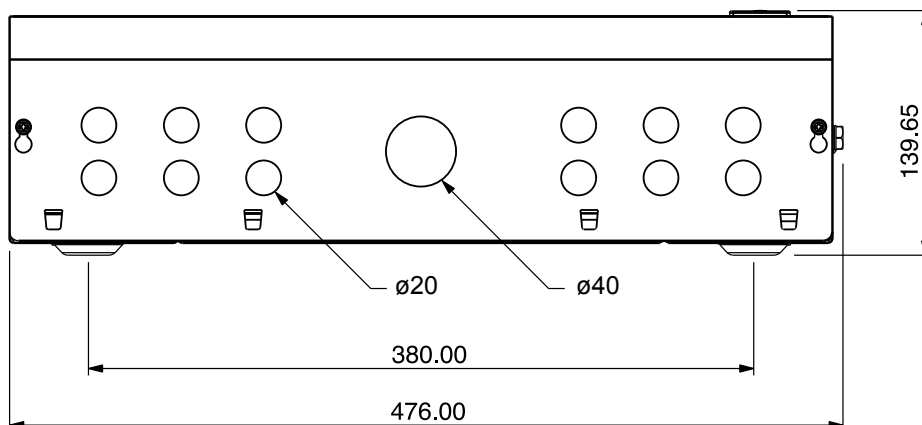
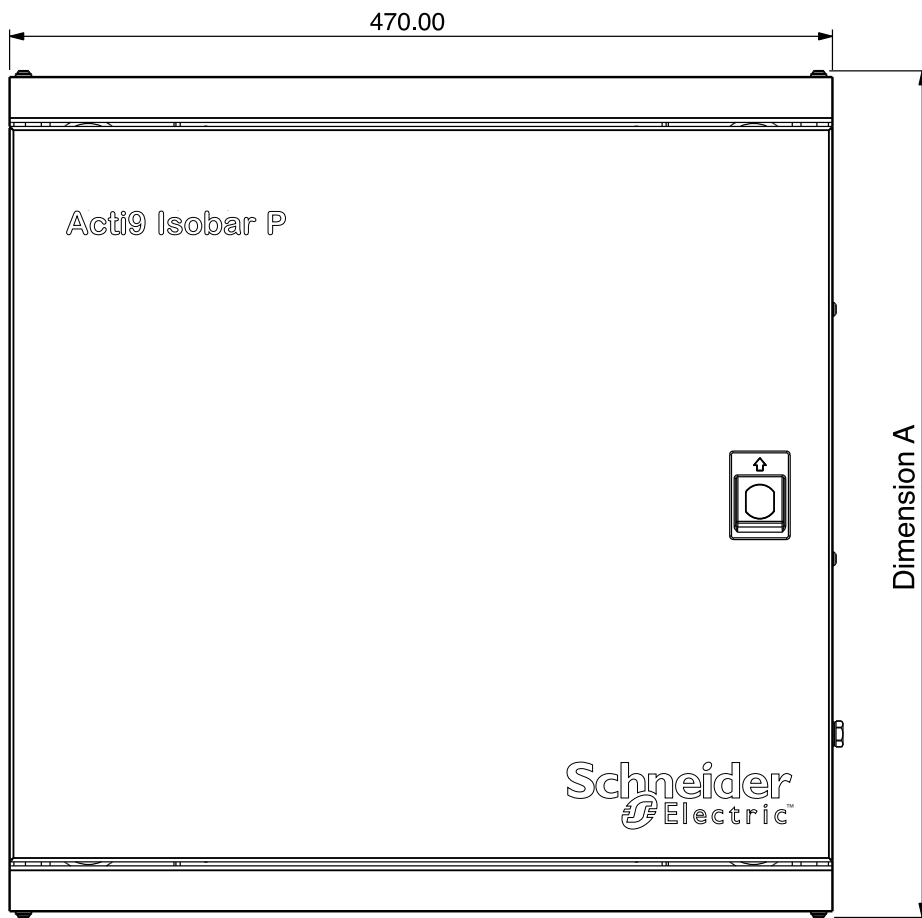

Heavy duty distribution board (125A)

Part number	Number of TP ways	Dimensions (mm)			Weight
		Height	Width	Depth	
SEA9BPN6HDGK/G-R	6	650	600	290*	32.4Kg
SEA9BPN8HDGK/G-R	8	650	600	290*	32.9Kg
SEA9BPN12HDGK/G-R	12	850	600	290*	40.1Kg
SEA9BPN16HDGK/G-R	16	850	600	290*	41.4Kg

* Denotes the maximum depth dimensions with key fitted.

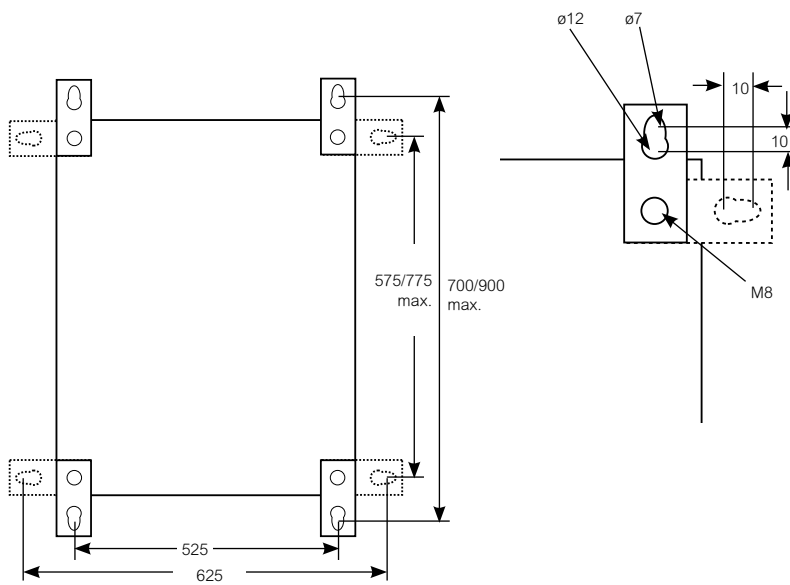

B board extension box enclosures	
Part number	A
SEA9BNEXN	124
SEA9BNEX034N	140
SEA9BNKWH	124
SEA9BNEXA14N	140
SEA9BN100CCI	140
SEA9PNDSI	124

* Not compatible with HDGR and HDGK heavy duty distribution board

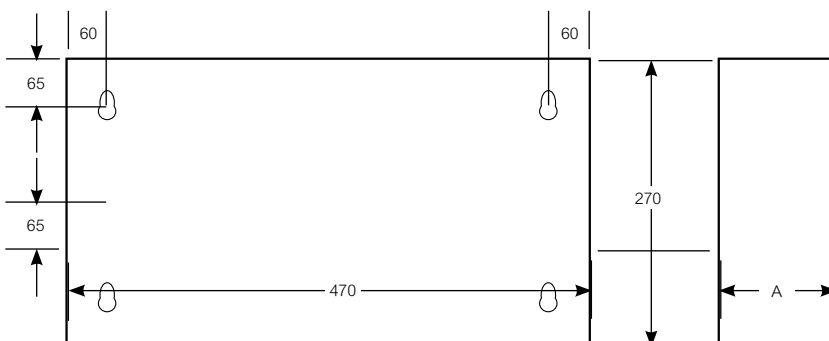

B Board metering

Dual metering extension enclosure

Part number	Dimensions (mm)			Weight
	Height	Width	Depth	
SEA9BNDM160SD	745	1147	139	22 Kg
SEA9BNDM200SD	745	1147	139	22 Kg
SEA9BNDM250SD	745	1147	139	22 Kg
SEA9BNDM160M	745	1147	139	22 Kg
SEA9BNDM200M	745	1147	139	22 Kg
SEA9BNDM250M	745	1147	139	22 Kg

Split metered distribution boards

Part number	Dimensions (mm)			Weight
	Height	Width	Depth	
SEA9BPN1258S8	1294	470	139	28 Kg
SEA9BPN12514S8	1294	470	139	28 Kg
SEA9BPN12516S6	1294	470	139	28 Kg
SEA9BPN12518S4	1294	470	139	28 Kg
SEA9BPN2508S8	1694	470	139	32 Kg
SEA9BPN25014S8	1694	470	139	32 Kg
SEA9BPN25016S6	1694	470	139	32 Kg
SEA9BPN25018S4	1694	470	139	32 Kg

AFDD devices

Part number	Dimensions (mm)			Weight
	Height	Width	Depth	
A9FDD232	81	36	72	0.22 Kg

KQ Loadcenter Dimensions



KQ Loadcenter dimensions

A type distribution board

Part number	Dimensions (mm)			
	A	B	C	D
SE125A6	273	300	166.8	245
SE125A8	345	300	238.8	245
SE125A12	417	300	310.8	245
SE125A16	489	300	382.8	245
SE125A24*	417	530	310.8	245
SEAE16	489	300	382.8	245

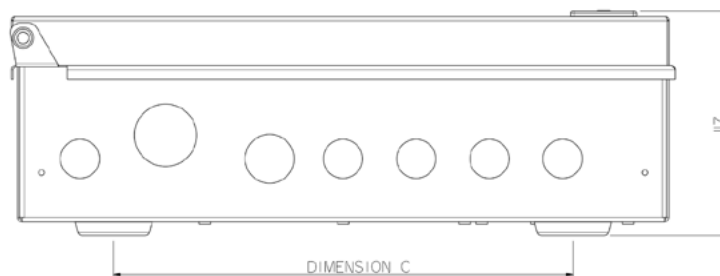
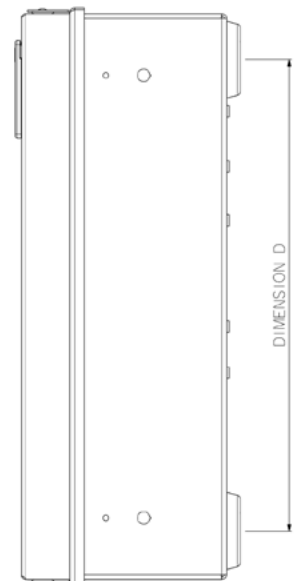

KQ Loadcenter dimensions

B type distribution board - 250A

Part number	Dimensions (mm)	
	A	B
SE12B250	484	386
SE18B250	484	386
SE24B250	538	440
SE36B250	700	602
SE48B250	808	710
SE54B250	862	764
SE72B250	1024	872

Split metering distribution boards

Part number	Dimensions (mm)	
	A	B
125 amp	1290	1002
250 amp	1694	1406

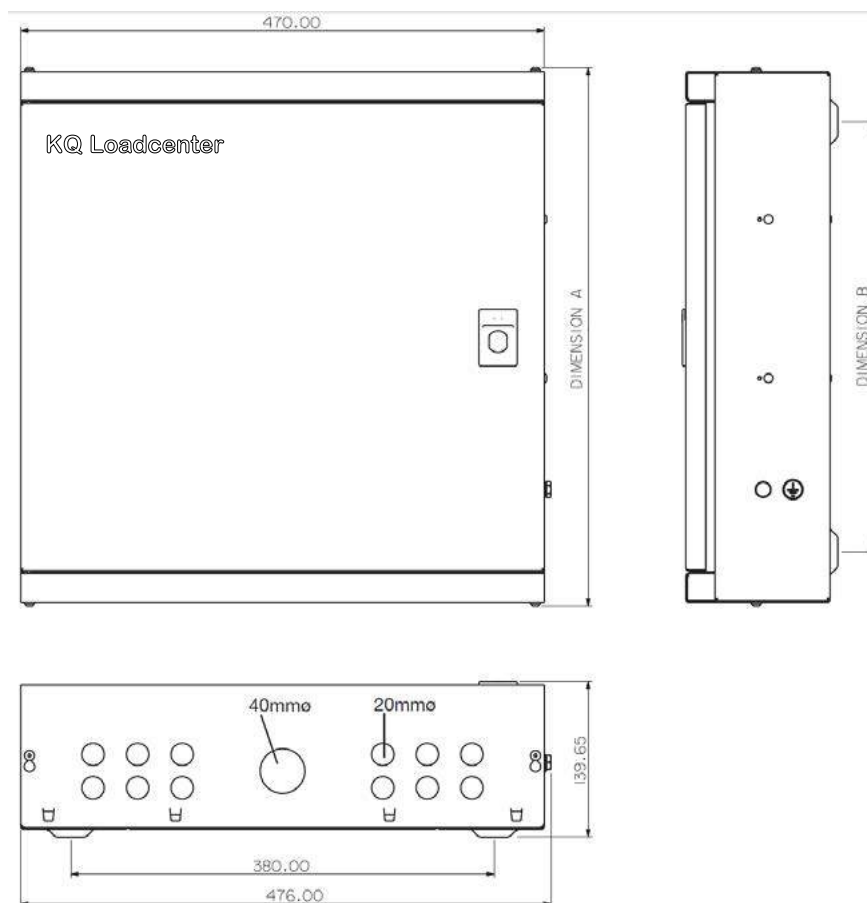

MID 3 Phase kWh kit modbus communications and pulsed output (Includes A9MEM3255)

Reference number	Dimensions (mm)		
	Height	Width	Depth
SE250MET	470	270	139

Split meter board (including incomers)

Reference number	Dimensions (mm)		
	Height	Width	Depth
SEA10S10 *	484	470	139
SEA14S14 *	530	417	139

Split metering board 125A

Reference number	Dimensions (mm)		
	Height	Width	Depth
SEB36S24125	1290	470	139
SEB42S18125	1290	470	139
SEB48S12125	1290	470	139

Split metering board 250A

Reference number	Dimensions (mm)		
	Height	Width	Depth
SEB36S24250	1290	470	139
SEB42S18250	1290	470	139
SEB48S12250	1290	470	139

Steel enclosures with plain cover and door

Reference number	Dimensions (mm)		
	Height	Width	Depth
SE12BCD	484	470	139
SE18BCD	538	470	139
SE36BCD	700	470	139
SE54BCD	808	470	139

Steel enclosures with DIN rails and a front cover assembly and door

Reference number	Dimensions (mm)		
	Height	Width	Depth
SE12B2D	484	470	139
SE18B2D	538	470	139
SE36B3D	700	470	139
SE54B4D	808	470	139

Residual Current Circuit Breakers - AC type

Reference number	Dimensions (mm)			Weight (Kg)
	Height	Width	Depth	
SED40032	81	36	75	0.227
SED40102	81	36	75	0.227
SED63032	81	36	75	0.227
SED63102	81	36	75	0.227
SED63302	81	36	75	0.227
SED80032	81	36	75	0.227
SED100032	81	36	75	0.227
SED100102	81	36	75	0.227
SED25034	81	72	75	0.428
SED25104	81	72	75	0.428
SED25304	81	72	75	0.428
SED40034	81	72	75	0.428
SED40104	81	72	75	0.428
SED40304	81	72	75	0.428
SED63034	81	72	75	0.428
SED63104	81	72	75	0.428
SED63304	81	72	75	0.428
SED80034	81	72	75	0.500
SED100304	81	72	75	0.500
SED100304S	81	72	75	0.500

Steel enclosure with 1 row of DIN rails and a front cover assembly and door

Reference number	Dimensions (mm)		
	Height	Width	Depth
SE17BES	270	470	139

Steel enclosure

Reference number	Dimensions (mm)		
	Height	Width	Depth
SEBES	270	470	124

Extra service units 125A (combination of a standard board and DIN rail enclosure)

Reference number		Dimensions (mm)			
		Height	Width	Depth	
SE12B250	+	SE17BES	270	470	139
SE18B250	+	SE12B2D	484	470	139
SE24B250	+	SE18B2D	538	470	139
SE36B250	+	SE36B3D	700	470	139
SE48B250	+	SE54B4D	808	470	139

Easy9 Dimensions

Dimensions

Part Number	Type	Usable ways	Height (mm)	Width (mm)	Depth (mm)
EZ9E2MCU	Standard	2	277	213	120
EZ9E4MCU	Standard	4	277	249	120
EZ9E6MCU	Standard	6	277	285	120
EZ9E8MCU	Standard	8	277	321	120
EZ9E12MCU	Standard	12	277	393	120
EZ9E16MCU	Standard	16	277	465	120
EZ9E20MCU	Standard	20	277	537	120
EZ9EFS12CMCU	Flexible split	12	277	465	120
EZ9EFS16CMCU	Flexible split	16	277	537	120
EZ9ER4R4MCU	Split	8	277	393	120
EZ9ER6R6MCU	Split	12	277	465	120
EZ9ER6R6CMCU	Split	12	277	465	120
EZ9ER8R8CMCU	Split	16	277	537	120
EZ9ES2R5R5CMCU	Multiple	12	277	465	120
EZ9ES2R7R7CMCU	Multiple	16	277	537	120
EZ9ER4R4MRE	Split	8	277	393	120
EZ9ER6R6MRE	Split	12	277	465	120
EZ9ES2R5R5CMRE	Multiple	12	277	465	120
EZ9EGARAGE63	Garage	2	277	213	120
EZ9ESHOWER63	Shower	2	277	213	120
EZ9EPVR6R6CMCU	PV	12	277	537	120
EZ9ESLR7R6CMCU	SPD	13	277	537	120
EZ9ESL3R5R5CMCU	SPD	13	277	537	120

Dimensions

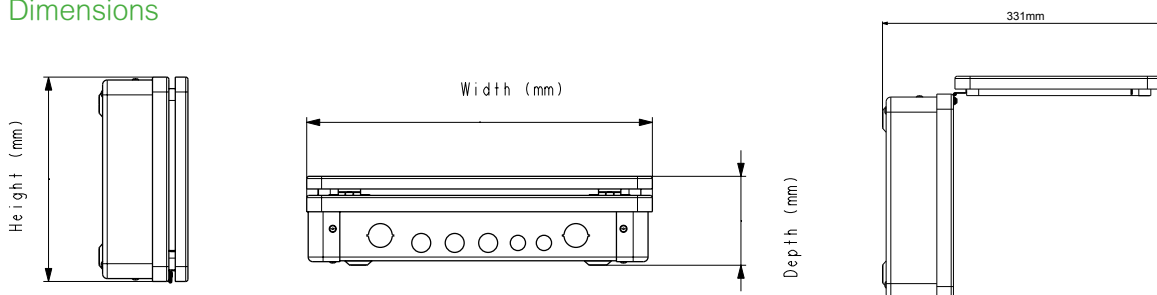

Dimensions / knockouts

Part Number	Dimensions (mm)		44x86mm	Dia. 32mm	Dia. 25mm	Dia. 20mm	Dia. 32mm (rear)
	A	B	D	E	F	G	H
EZ9E2MCU	205	75	-	1	-	1	2
EZ9E4MCU	241	111	-	1	-	2	2
EZ9E6MCU	277	139	2	1	2	1	-
EZ9E8MCU	313	171	2	1	2	2	-
EZ9E12MCU	385	250	4	2	3	-	-
EZ9E16MCU	457	322	4	2	3	2	-
EZ9E20MCU	529	394	6	2	3	2	-
EZ9EFS12CMCU	457	322	4	2	3	2	-
EZ9EFS16CMCU	529	394	6	2	3	2	-
EZ9ER4R4MCU	385	250	4	2	3	-	-
EZ9ER6R6MCU	457	322	4	2	3	2	-
EZ9ER6R6CMCU	457	322	4	2	3	2	-
EZ9ER8R8CMCU	529	394	6	2	3	2	-
EZ9ES2R5R5CMCU	457	322	4	2	3	2	-
EZ9ES2R7R7CMCU	529	394	6	2	3	2	-
EZ9ER4R4MRE	385	250	4	2	3	-	-
EZ9ER6R6MRE	457	322	4	2	3	2	-
EZ9ES2R5R5CMRE	457	322	4	2	3	2	-
EZ9EGARAGE63	205	75	-	1	-	1	2
EZ9ESHOWER63	205	75	-	-	-	-	-
EZ9EPVR6R6CMCU	529	394	6	-	-	-	-
EZ9ESLR7R6CMCU	529	394	6	-	-	-	-
EZ9ESL3R5R5CMCU	529	394	6	-	-	-	-

Dimensions (mm)

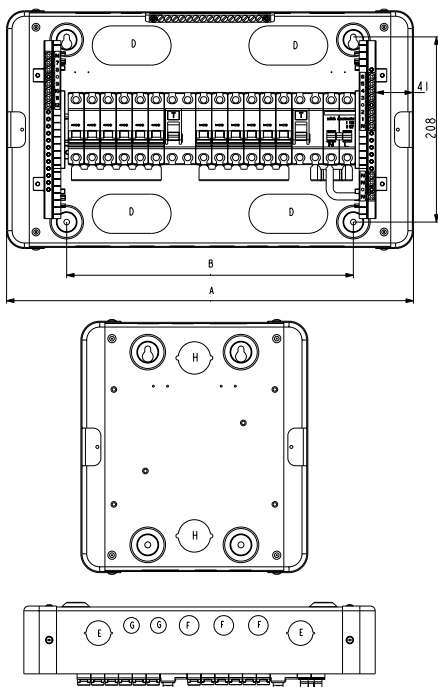

Semi-flush mount frame

Ref No	Description	External dimensions (mm)		Internal cut out dimensions (mm)	
		A	B	C	D
EZ9EFLKIT12	EZ9 Semi-flush mount frame 12way	319	437	273	391
EZ9EFLKIT16	EZ9 Semi-flush mount frame 16way	319	509	273	463
EZ9EFLKIT20	EZ9 Semi-flush mount frame 20way	319	581	273	535

