

Product datasheet

Specifications



Expansion module, Modicon M172/M172/M173, optimized and performance, 28 IO

TM172E28R

Main

Range Of Product	Modicon M171/M172
Product Or Component Type	Additional I/O module
Product Specific Application	HVAC control
Total Inputs/Outputs	28
Discrete Input Number	2 4
Discrete Output Number	3 for relay outputs SPST with same common 2 for relay outputs SPST with same common
Discrete Output Current	3 A for relay SPST
Analogue Input Number	10 configurable by pair
Analogue Output Number	2 programmable

Complementary

Number Of Port	1 CAN port - screw terminal block
Input/Output Number	2 analog output(s) 6 digital input(s) 10 analog input(s) 10 digital output(s)
Discrete Input Logic	2 positive logic (sink) up to 2 kHz 4 positive logic (sink)
Discrete Input Voltage	24 V AC/DC
Discrete Input Current	2.5 mA AC/DC
Input Impedance	20 kOhm
Analogue Input Type	NTC NK103 Beta 3977 temperature probe - 40...137 °C - resolution: 0.1 °C at 10 kOhm (at 25 °C) NTC 103AT-2 Beta 3435 temperature probe - 50...110 °C - resolution: 0.1 °C at 10 kOhm (at 25 °C) current 0...20 mA - resolution: 1 digit at < 150 Ohm current 4...20 mA - resolution: 1 digit at < 150 Ohm voltage 0...10 V - resolution: 1 digit at > 10 kOhm voltage 0...5 V - resolution: 1 digit at > 20 kOhm (absolute or ratiometric) impedance 0...1500 hOhm - resolution: 1 hOhm at 10 kOhm impedance 0...300 daOhm - resolution: 1 daOhm at 2 kOhm direct input - resolution: 1 digit (Dry contact) PTC - 55...150 °C - resolution: 0.1 °C at 2 kOhm Pt 1000 temperature probe - 200...850 °C - resolution: 0.1 °C at 2 kOhm

Price is "List Price" and may be subject to a trade discount – check with your local distributor or retailer for actual price.

Measurement Accuracy	NTC NK103 - 40...+110 °C +/- 1 °C NTC NK103 110...137 °C +/- 1.9 °C NTC 103AT-2 - 50...110 °C +/- 1 °C PTC - 55...+135 °C +/- 1.1 °C PTC - 150...135 °C +/- 3.1 °C Pt 1000 - 200...-100 °C +/- 5 °C Pt 1000 - 100...-50 °C +/- 3 °C Pt 1000 - 50...+200 °C +/- 1.5 °C Pt 1000 200...600 °C +/- 15 °C Pt 1000 600...850 °C +/- 30 °C 0...20 mA 0...4 mA +/- 2 % of full scale +/- 1 digit 0...20 mA 4...20 mA +/- 1 % of full scale +/- 1 digit 4...20 mA +/- 1 % of full scale +/- 1 digit 0...10 V +/- 1 % of full scale +/- 1 digit 0...5 V +/- 1 % of full scale +/- 1 digit HOhm 0...700 hOhm +/- 10 hOhm HOhm 700 hOhm...1200 hOhm +/- 25 hOhm HOhm 1200 hOhm...1500 hOhm +/- 60 hOhm DaOhm 0...300 daOhm +/- 2.5 daOhm
Sensor Power Supply	5 V DC at 50 mA 24 V DC at 125 mA
[Us] Rated Supply Voltage	24 V +/- 10 % AC 20...38 V DC
Power Consumption In W	24 VA at 24 V AC 15 W at 24 V DC
Realtime Clock	Without clock
Display Type	Without display
Overvoltage Category	II
Mounting Support	DIN rail Panel mounting with accessory
Width	72 mm
Height	110 mm
Depth	59 mm
Net Weight	0.19 kg

Environment

Directives	2014/35/EU - low voltage directive 2014/30/EU - electromagnetic compatibility
Standards	IEC 61000-4-4 EN 60068-2-27 CSA E60730-2-9 IEC 61000-4-11 CAN/CSA-E60730-1 UL 60730-2-9 EN 60730-2-9 EN 60730-1 IEC 61000-4-5 IEC 61000-4-3 EN 60068-2-6 Fc IEC 61000-4-2 UL94 (material V0)
Product Certifications	cURus EAC CE RCM CSA
Ambient Air Temperature For Operation	-20...65 °C conforming to UL 60730-1
Ambient Air Temperature For Storage	-30...70 °C
Relative Humidity	5...95 % non-condensing
Ip Degree Of Protection	IP20

Pollution Degree	2
------------------	---

Packing Units

Unit Type Of Package 1	PCE
------------------------	-----

Number Of Units In Package 1	1
------------------------------	---

Package 1 Height	13.500 cm
------------------	-----------

Package 1 Width	9.000 cm
-----------------	----------

Package 1 Length	12.700 cm
------------------	-----------

Package 1 Weight	258.000 g
------------------	-----------

Unit Type Of Package 2	S02
------------------------	-----

Number Of Units In Package 2	8
------------------------------	---

Package 2 Height	15.000 cm
------------------	-----------

Package 2 Width	30.000 cm
-----------------	-----------

Package 2 Length	40.000 cm
------------------	-----------

Package 2 Weight	2.330 kg
------------------	----------

Sustainability

Green Premium™ label is Schneider Electric's commitment to delivering products with best-in-class environmental performance. Green Premium promises compliance with the latest regulations, transparency on environmental impacts, as well as circular and low-CO₂ products.

Guide to assessing product sustainability is a white paper that clarifies global eco-label standards and how to interpret environmental declarations.

[Learn more about Green Premium >](#)

[Guide to assess a product's sustainability >](#)



Transparency RoHS/REACH

Resource performance

✓ Upgradeable Through Digital Modules
And Upgraded Components

Well-being performance

✓ Mercury Free

✓ Rohs Exemption Information Yes

Certifications & Standards

Reach Regulation [REACH Declaration](#)

Eu Rohs Directive Pro-active compliance (Product out of EU RoHS legal scope)

China Rohs Regulation [China RoHS declaration](#)

Environmental Disclosure [Product Environmental Profile](#)

Weee The product must be disposed on European Union markets following specific waste collection and never end up in rubbish bins

Circularity Profile [End of Life Information](#)

Dimensions Drawings

Dimensions Drawings

Dimensions

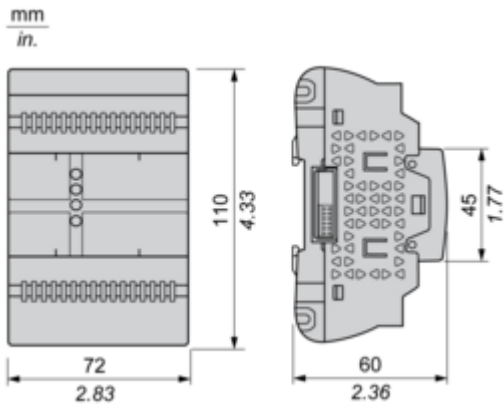

Mounting and Clearance

Mounting Positions

Correct Mounting Position

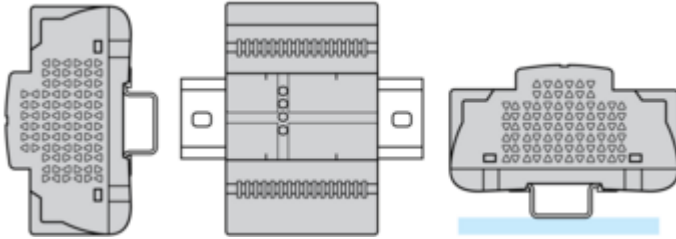

Incorrect Mounting Position

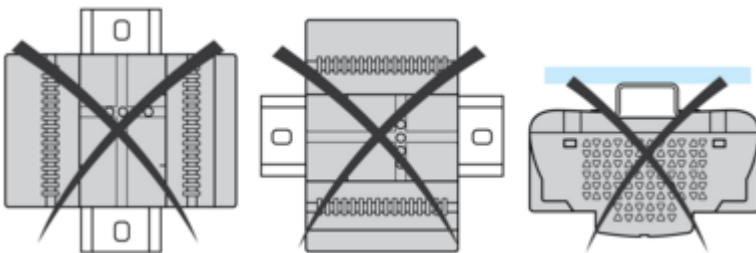

Clearance

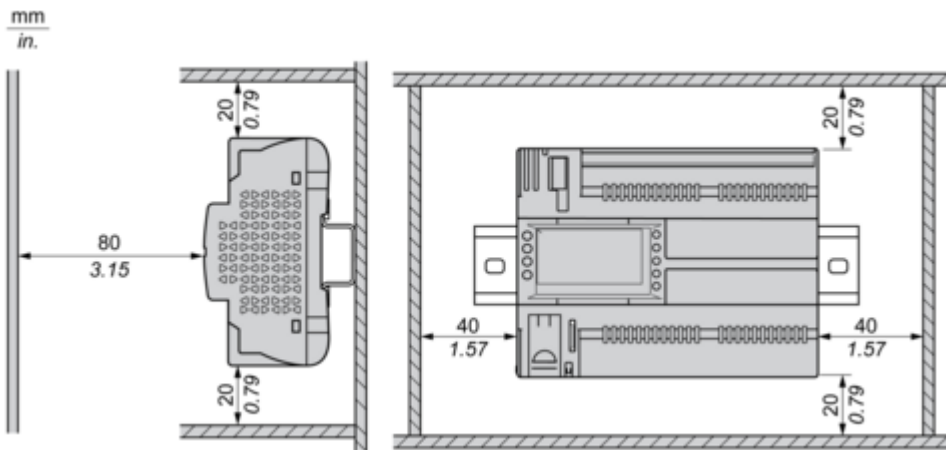

Connections and Schema

Power Supply

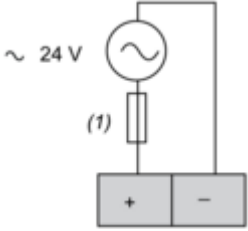
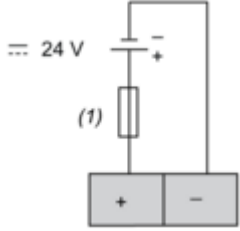
24 Vac	24 Vdc
	
(1) Type T fuse 2 A	

CN2 Fast Digital Inputs

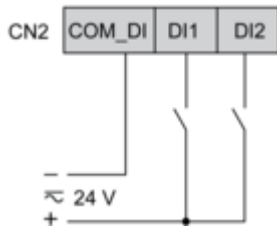

CN8 Digital Inputs

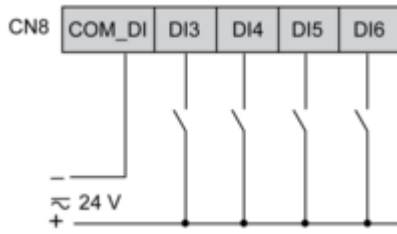

CN5, CN4, CN11, CN10 High Voltage Relay SPST Digital Output

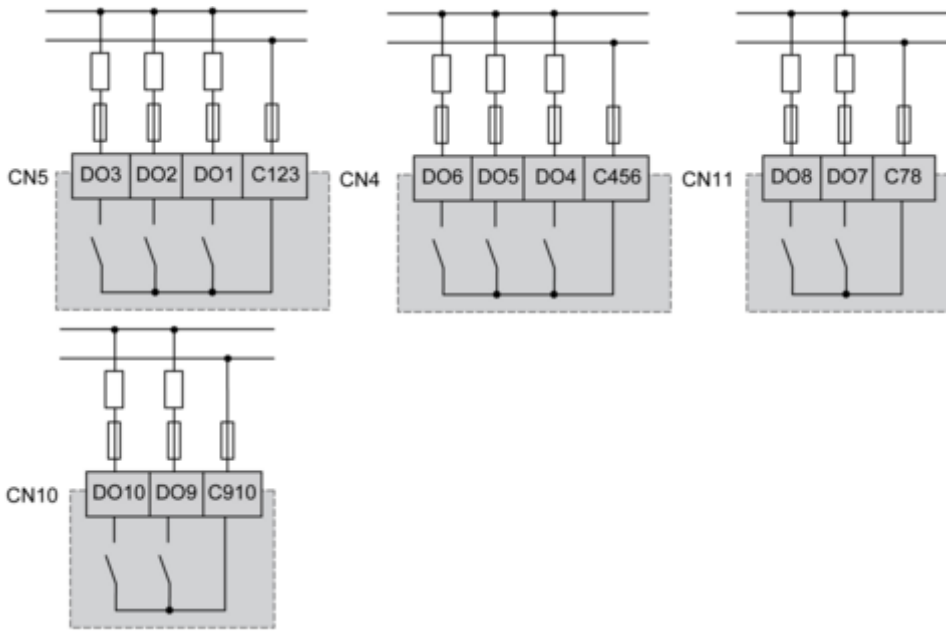

CN3, CN9 Analog Inputs

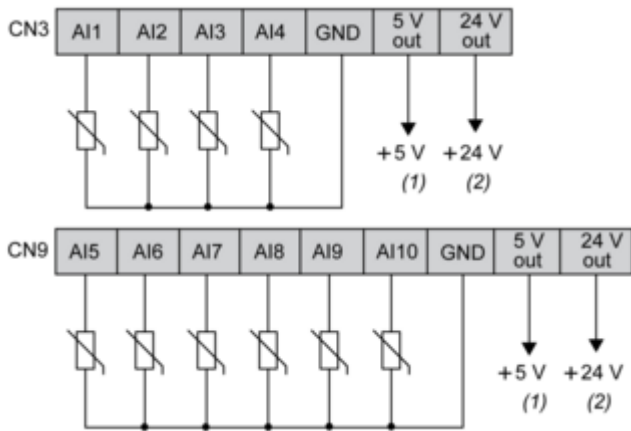

- (1) (CN3 + CN9) Max. current : 50 mA.
- (2) (CN3 + CN9) Max. current : 125 mA.

CN7 Analog Outputs

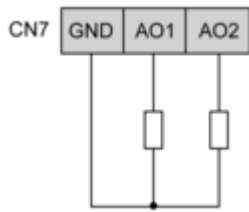

AO1, AO2 can be used also as PWM generator, up to 2kHz.

CN1 CAN Expansion Bus Port

